

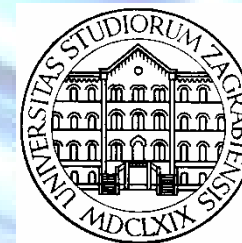

**Faculty of Chemical Engineering and Technology**  
University of Zagreb



# Petroleum Refining:

Introduction, Products, Refinery's Configurations, Hydrogen Technologies

**Ante Jukić**

ZAVOD ZA TEHNOLOGIJU NAFTE I PETROKEMIJU

HR-10000 Zagreb, Savska cesta 16, p.p. 177 / Tel. +385-1-4597125 / E-adresa: [ajukic@fkit.hr](mailto:ajukic@fkit.hr)

## Gasoline, Diesel, and LPG Technologies

In this section we will be describing the different refining technologies relating to Gasoline, Diesel and LPG. Although these are labeled as conventional technologies, refineries today have become increasingly more efficient and efforts across the globe are being made to invest in better performing technologies and processes that save energy and decrease each refineries environmental impact whilst meeting increasingly more stringent fuel product specifications.

As can be seen below a basic refinery typically produces a variety of products including: LPG; petrochemicals; gasoline; jet fuel; paraffin for lighting and heating; lubricating oils, waxes and polishes; heavy fuel oil, and bitumen for roads and roofing.

### Products Produced by Refineries

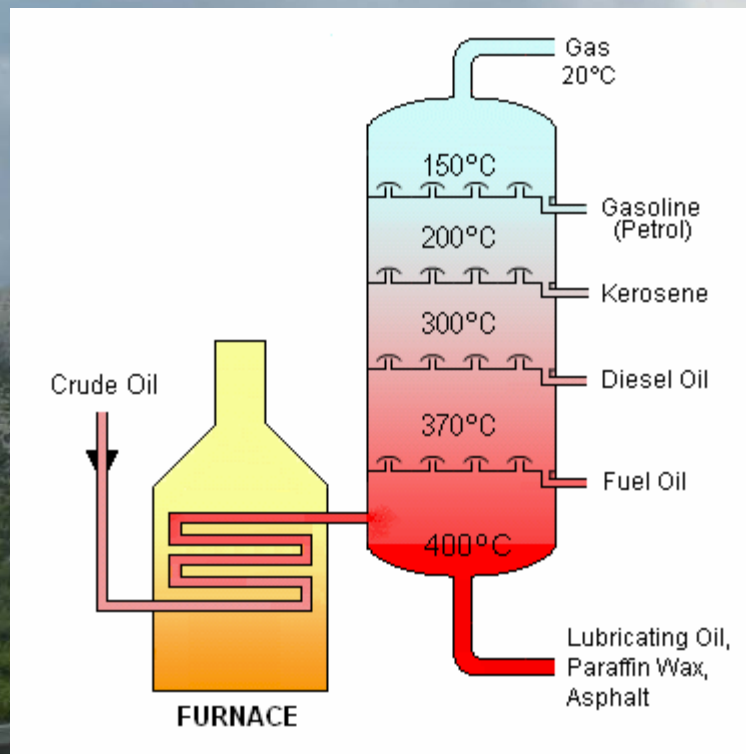

## Processing units used in refineries

- **Crude Oil Distillation unit:** distills the incoming crude oil into various fractions for further processing.
- **Vacuum Distillation unit:** further distills the residue oil from the bottom of the crude oil distillation unit.
- **Naphtha Hydrotreater unit:** uses hydrogen to desulfurize the naphtha fraction from the crude oil distillation or other units within the refinery.
- **Catalytic Reforming unit:** converts the desulfurized naphtha molecules into higher-octane molecules to produce reformate, which is a component of the end-product gasoline or petrol.
- **Alkylation unit:** converts isobutane and butylenes into alkylate, which is a very high-octane component of the end-product gasoline or petrol.
- **Isomerization unit:** converts linear molecules such as normal pentane into higher-octane branched molecules for blending into the end-product gasoline. Also used to convert linear normal butane into isobutane for use in the alkylation unit.
- **Distillate Hydrotreater unit:** uses hydrogen to desulfurize some of the other distilled fractions from the crude oil distillation unit (such as diesel oil).
- **Merox (mercaptan oxidizer) or similar units:** desulfurize LPG, kerosene or jet fuel by oxidizing undesired mercaptans to organic disulphides.
- **Amine gas treater, Claus unit, and tail gas treatment** for converting hydrogen sulphide gas from the hydrotreaters into end-product elemental sulphur.
- **Fluid catalytic cracking (FCC) unit:** upgrades the heavier, higher-boiling fractions from the crude oil distillation by converting them into lighter and lower boiling, more valuable products.
- **Hydrocracker unit:** uses hydrogen to upgrade heavier fractions from the crude oil distillation and the vacuum distillation units into lighter, more valuable products.
- **Visbreaker unit** upgrades heavy residual oils from the vacuum distillation unit by thermally cracking them into lighter, more valuable reduced viscosity products.
- **Delayed coking and Fluid coker units:** convert very heavy residual oils into end-product petroleum coke as well as naphtha and diesel oil by-products.

## Auxiliary facilities required in refineries

- **Steam reformer unit:** converts natural gas into hydrogen for the hydrotreaters and/or the hydrocracker.
- **Sour water stripper unit:** Uses steam to remove hydrogen sulfide gas from various wastewater streams for subsequent conversion into end-product sulfur in the Claus unit.
- Utility units such as **cooling towers** for furnishing circulating cooling water, **steam generators**, instrument air systems for pneumatically operated **control valves** and an **electrical substation**.
- Wastewater collection and treating systems consisting of API **separators**, **dissolved air flotation** (DAF) units and some type of further treatment (such as an **activated sludge** biotreater) to make the wastewaters suitable for reuse or for disposal.
- Liquefied gas (LPG) **storage vessels** for propane and similar gaseous fuels at a pressure sufficient to maintain them in liquid form. These are usually spherical vessels or *bullets* (horizontal vessels with rounded ends).
- **Storage tanks** for crude oil and finished products, usually vertical, cylindrical vessels with some sort of vapour emission control and surrounded by an earthen berm to contain liquid spills.

# Refining end-products

The primary end-products produced in petroleum refining may be grouped into four categories: light distillates, middle distillates, heavy distillates and others.

## Light distillates

- Liquid petroleum gas (LPG)
- Gasoline (also known as petrol)
- Kerosene
- Jet fuel and other aircraft fuel.

## Middle distillates

- Automotive and rail-road diesel fuels
- Residential heating fuel
- Other light fuel oils

## Heavy distillates

- Heavy fuel oils
- Bunker fuel oil and other residual fuel oils

## Others

Many of these are not produced in all petroleum refineries.

- Speciality petroleum naphthas
- Speciality solvents
- Elemental sulphur, and sometimes sulphuric acid
- Petrochemical feed-stocks
- Asphalt and tar
- Petroleum coke
- Lubricating oils
- Waxes and greases
- Transformer and cable oils
- Carbon black



## Burning Hydrocarbons

Burning hydrocarbons is the main source of energy that the world uses today thus making it the most valuable energy resource. As hydrocarbons burn, it creates an immense amount of energy and heat which is utilized in heating, transport, or electricity generation around the world. Hypothetically the only waste of burning hydrocarbons would be water and carbon dioxide but many sources are contaminated with impurities which can produce toxic byproducts such as arsenic or mercury. Incomplete combustion of the fuel also produces carbon monoxide which is harmful to humans. *Chemically speaking, pure methane (CH<sub>4</sub>) is the cleanest fuel because it only produces one CO<sub>2</sub> molecule for every two water molecules.*

Crude oil or petroleum (literally meaning 'rock oil') is a naturally occurring liquid stored in earth formations consisting of complex mixtures of hydrocarbons.

Crude oil is predominately processed and used as a fuel oil or gasoline.

Petroleum is converted into energy rich fuels such as gasoline, diesel, jet, heating, Liquid Petroleum Gas (LPG), and other fuel oils. In processing crude oil 84% (by volume) of the hydrocarbons are converted into such products. Crude has a high energy density, relatively abundant, and is easily transportable.

The classification of crude oil is often categorized by its relative weight or viscosity and the origin of the oil (ie WTI or Brent). This is where terminology of light, intermediate, or heavy crude oil is used.

Furthermore, if the oil is considered 'sweet' there is very little sulfur content, where as if it is considered 'sour' there is high sulfur or other impurity content in the oil.

Petroleum is also used in many chemical products, such as pharmaceuticals, pesticides, fertilizers, solvents, and plastics. The 16% not used for fuel is directed towards these products.

# Gasoline

**Its major purpose:** Gasoline is a crude oil derived liquid mixture of refinery streams.

It is used as a fuel for today's vehicle's internal combustion engines, better known as "gasoline engines".

**How is it made:** The gasoline components are produced from crude oil through a variety of refinery processes and are subsequently mixed in such a way that the final gasoline blend meets the mandated quality requirements.

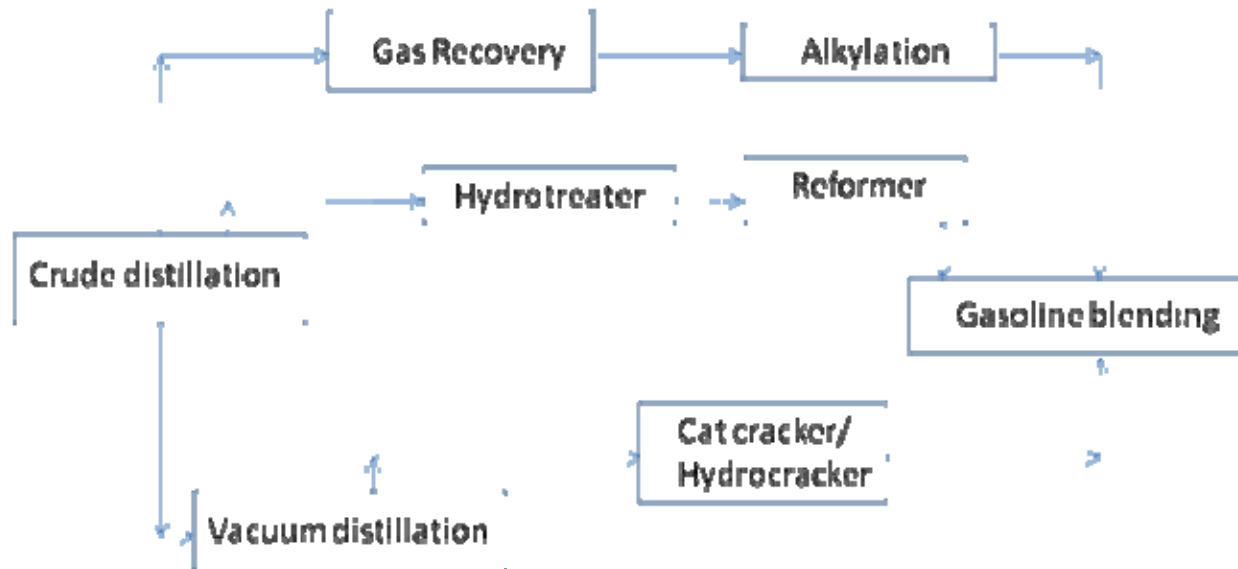

**The chemical composition of a gasoline blend** consists of hydrocarbon chains including **paraffin** (alkanes), **naphthenes** (cyclo-alkanes), **aromatics** and **olefins** (alkenes).

They have between five and twelve carbon atoms per molecule ( $C_5 - C_{12}$ ).

These molecules also contain hetero-atoms such as oxygen, nitrogen and sulphur, which cause the formation of pollutant emissions upon combustion.

#### Performance characteristics:

Modern gasoline for use in the internal combustion engine exhibits the following key characteristics:

- The fuel has a high energy density.
- It has good ignition properties.
- It contains low concentrations of pollutant precursors.
- It allows the use of advanced exhaust treatment equipment.
- It allows easy and safe handling, transport and storage.
- Its use leaves a small environmental and climate footprint.

Fuel legislation is ensuring that these requirements are met and the specifications allow vehicle manufacturers to apply technologies which in turn ensure that tailpipe emissions are reduced.

These requirements are irrespective of the composition of the fuels, and therefore would also apply when conventional fossil fuels are blended with increasing quantities of biofuel components.

**In order to enhance the fuel performance further and to distinguish certain fuels from the baseline products, it is now common practice to add performance chemicals (additives) to the fuels.**

These additives can improve octane content, enhance engine cleanliness and enhance start-up and running performance in a wide range of climatic circumstances.



**Legislated specifications:** Over the years the properties of gasoline have steadily evolved, in response to the increasing concerns related to tail pipe emissions of pollutants (EN 228, national directives).

Modern gasoline fuels therefore now contain very low concentrations of components which could form pollutant emissions. At the same time, the vehicle engine and exhaust after treatment technology, has progressed significantly to meet the very stringent requirements on tailpipe emissions.

There is no single world specification for automotive gasoline. The table below illustrates the current mandated lower and higher gasoline properties, their limits and their environmental and performance factors across the globe. For specific fuel quality specifications go to [www.ifqc.org](http://www.ifqc.org).

### Main Gasoline Properties, Limits & Environmental/Performance Factors

Main Gasoline Properties	Environmental & Performance Factors	Typical Values
Aromatics	<p>Aromatics are fuel molecules that contain at least one benzene ring. In general, aromatics are good octane components of gasoline and high-energy density fuel molecules.</p> <p>Fuel aromatic content can increase engine deposits and increase tailpipe emissions, including CO<sub>2</sub>. Gasoline aromatic content also has a direct effect on tailpipe CO<sub>2</sub> emissions.</p> <p>The reduction of aromatics from 50 to 20% was found to decrease CO<sub>2</sub> emissions by 5%.</p>	30-57 vol%
Benzene	<p>Benzene is a naturally occurring constituent of crude oil and is also a product of catalytic reforming that produces high octane gasoline streams. It is also a known human carcinogen. The control of benzene levels in gasoline is the most direct way to limit evaporative and exhaust emissions of benzene from automobiles.</p>	1-7 vol %

Main Gasoline Properties	Environmental & Performance Factors	Typical Values						
Distillation	Distillation of gasoline yields either a set of 'T' points (T50 is the temperature at which 50% of the gasoline distills) or 'E' points (E100 is the percentage of a gasoline distilled at 100 degrees). Excessively high T50 (low E100) can lead to poor starting and warm-up performance at moderate ambient temperatures. Control of the Distillation Index (DI), derived from T10,T50,T90, and oxygen content can also be used to assure good cold start and warm-up performance.	<table border="0"> <tr> <td>T10 (°C)</td> <td>35 – 82</td> </tr> <tr> <td>T50 (°C)</td> <td>66 – 140</td> </tr> <tr> <td>T90 (°C)</td> <td>120 – 200</td> </tr> </table>	T10 (°C)	35 – 82	T50 (°C)	66 – 140	T90 (°C)	120 – 200
T10 (°C)	35 – 82							
T50 (°C)	66 – 140							
T90 (°C)	120 – 200							
Octane	Octane is a measure of a gasoline's ability to resist auto-ignition; auto-ignition can cause engine knock. When a customer uses gasoline with an octane level lower than that required, knocking may result which could lead to severe engine damage. Octane properties include R	<table border="0"> <tr> <td>RON</td> <td>76 – 98</td> </tr> <tr> <td>MON</td> <td>75 – 97</td> </tr> </table>	RON	76 – 98	MON	75 – 97		
RON	76 – 98							
MON	75 – 97							
Olefins	Olefins are unsaturated hydrocarbons and, in many cases, are also good octane components of gasoline. However, olefins in gasoline can lead to deposit formation and increased emissions of reactive (i.e., ozone forming) hydrocarbons and toxic compounds. Olefins are thermally unstable and may lead to gum formation and deposits in an engine's intake system. Furthermore, their evaporation into the atmosphere as chemically reactive species contributes to ozone formation and their combustion products form toxic dienes.	5-38 vol%						
Oxygen Content	Oxygenated organic compounds, such as MTBE and ethanol, often are added to gasoline to increase octane or extend gasoline supplies. Oxygenating the fuel also may affect vehicle emissions (tailpipe, evaporative or both), performance and/or durability. Adding oxygenates to gasoline will induce a lean shift in engine stoichiometry, which, in turn, will reduce carbon monoxide (CO) emissions, especially from carburetted vehicles without electronic feedback controlled fuel systems.	0-3.7 wt%						
RVP (Volatility)	The vapor pressure must be tightly controlled at high temperatures to reduce the possibility of hot fuel handling problems, such as vapor lock or carbon canister overloading. Control of vapor pressure at high temperatures is also important in the reduction of evaporative emissions. At lower temperatures higher vapor pressure is needed to allow ease of starting and good warm-up performance.	35-107kPa						
Sulfur ppm (max)	Sulfur naturally occurs in crude oil. If the sulfur is not removed during the refining process it will contaminate vehicle fuel. Sulfur has a significant impact on vehicle emissions by reducing the efficiency of catalysts. Sulfur also adversely affects heated exhaust gas oxygen sensors. Reductions in sulfur will provide immediate reductions of emissions from all catalyst-equipped vehicles on the road.	10-2,500						

# Diesel

**Its major purpose:** Diesel fuel (also known as AGO) is a crude oil derived liquid mixture of refinery streams. It is used as a fuel to propel today's compression ignition engines installed in passenger cars, vans, trucks and buses. It is also used for heavy duty off-road equipment, for railways and for shipping (smaller engines/ships).

**How is it made:** The diesel components are produced from crude oil through a variety of refinery processes. Whereas initially most of the diesel was produced from crude oil distillation, with the growing demand for diesel fuels, diesel components are now increasingly produced through refinery cracking processes, converting heavy refinery streams into lighter fractions suitable for use as diesel blend components.

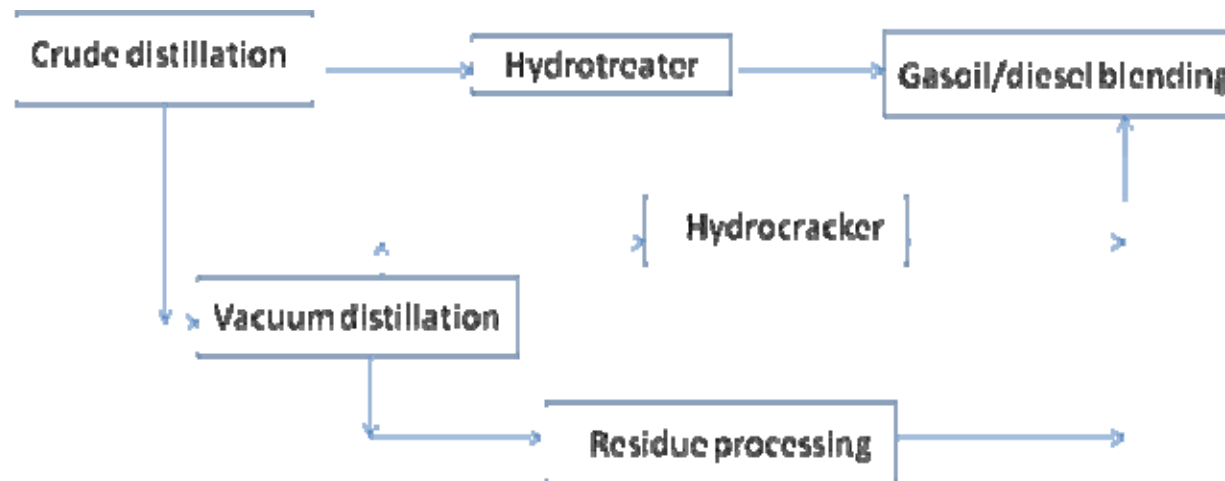

The composition of a diesel blend consists of a **mixture of saturated hydrocarbon chains and aromatic compounds with a boiling range between 200 and 350 °C**.

The diesel blends generally contain a significant concentration of saturated hydrocarbons (approximately 75%) to meet modern diesel fuel requirements.

### Performance characteristics:

A suitable diesel fuel for modern compression ignition engines would exhibit the following key characteristics:

- High energy density.
- Good ignition performance reflected by a good cetane quality.
- Contains low concentrations of pollutant precursors and poly-aromatics to allow optimal functioning of the engine and advanced exhaust emission treatment equipment.
- Exhibits good cold weather operability performance.
- Has good storage stability at ambient temperatures.
- Allows easy and safe handling, transport and storage.
- Leaves a small environmental and climate footprint.

Modern fuel legislation is ensuring that these requirements are met and the specifications allow vehicle manufacturers to apply technologies which in turn ensure that tailpipe emissions are reduced. These requirements are irrespective of the composition of the fuels and therefore would also apply when conventional fossil fuels are blended with increasing quantities of biofuel components.

## Main Automotive Diesel Properties Limits & Environmental/Performance Factors

Main Diesel Properties	Environmental & Performance Factors	Lower Limit - Higher Limit
Aromatics & Polyaromatics (PAH)	Aromatics are molecules that contain at least one benzene ring. The fuel aromatic content will affect combustion & the formation of emissions. Higher diesel aromatics and PAH increase emissions of NOX, particulates and PAH	Aromatics (vol%) 10 - 35 Polyaromatics (wt%) 1.4 - 11
Cetane Number (min)	Cetane number is a measure of the compression ignition behavior of a fuel; it influences cold startability, exhaust emissions. Increased cetane reduces NOX, HC, CO (depending on vehicle type and load) and combustion noise, and increases fuel consumption.	40 - 51
Cetane Index	Cetane index, which is based on measured fuel properties, is a calculated value that approximates the 'natural' cetane of a fuel. "Natural" cetane equals the cetane number when the fuel does not contain any cetane improver.	40 - 50
Density/Viscosity	The diesel fuel injection is controlled volumetrically or by timing of the solenoid valve. Variations in fuel density (and viscosity) result in variations in engine power and, consequently, in engine emissions and fuel consumption. Reduced density will reduce PM emissions (all diesel vehicles), NOX emissions (HDVs), increases fuel consumption and reduces power output .	Density (kg/m <sup>3</sup> ) 800 – 890 Viscosity (cSt) 1 – 9.5
Distillation °C	The distillation curve of diesel fuel indicates the amount of fuel that will boil off at a given temperature. The curve can be divided into three parts: <ul style="list-style-type: none"> <li>•The light end, which affects startability;</li> <li>•The region around the 50% evaporated point, which is linked to other fuel parameters such as viscosity and density; and,</li> <li>•The heavy end, characterized by the T90, T95 and final boiling points.</li> </ul> Too much fuel in the heavy end will result in coking and increased tailpipe emissions of soot/smoke/particulate matter.	T10 (°C) 235 T50 (°C) 245 - 310 T90 (°C) 282 - 370
Sulphur ppm	Sulphur naturally occurs in crude oil. Diesel fuel sulphur contributes significantly to fine particulate matter (PM) emissions, through the formation of sulphates both in the exhaust stream and, later, in the atmosphere. Sulphur can lead to corrosion and wear of engine systems. The efficiency of some exhaust after-treatment systems is reduced as fuel sulphur content increases, while others are rendered permanently ineffective through sulphur poisoning. As sulphur levels are reduced, fuel stability and lubricity requires special attention.	10 - 10,000

Source: WWFC, 2006 & International Fuel Quality Center (IFQC), 2008



## LPG (liquefied petroleum gas)

Its major purpose: Apart from its use for heating and cooking, as feedstock for petrochemical processes and as feedstock to produce high octane gasoline components through refinery alkylation, LPG has also - limited - use as fuel for internal combustion engines.

How is it made: Liquefied Petroleum Gas (LPG) refers to mixtures of petroleum gases released during the production of crude oil and natural gas and during the refining of crude oil.

The quantity of automotive LPG produced in refineries is generally very small (approximately 1-5%).

Mixtures of propane and butane are normally used for automotive LPG. Automotive LPG often contains small quantities of other components such as pentane, ethane, and propene.

### Performance characteristics:

- LPG's energy content on a volume basis is considerably lower (approximately 80%) than the gasoline it replaces, leading to increased vehicle fuel consumption.
- LPG has good ignition properties and a high octane number (RON: 90-110). LPG has also shown to increase diesel burning efficiency when mixed with diesel fuel from 75%-85% to 95%-98%.
- LPG contains very low concentrations of pollutant precursors thus facilitating the use of advanced exhaust treatment equipment.
- LPG vehicles produce 90% less particulate emissions, 50% less NO<sub>x</sub>, 75% less CO and 87% less ozone compared to gasoline. Relative to diesel, LPG vehicles produce 120 times less particulate matter and 80% less NO<sub>x</sub>.
- The carbon footprint for LPG is approximately 3.02 CO<sub>2</sub>/kg. This is approximately 17% less CO<sub>2</sub> compared to gasoline and approximately 2% less CO<sub>2</sub> compared to diesel, on a well to wheel basis.
- LPG is heavier than air and ignites more easily than gasoline or diesel and therefore requires careful handling, transportation and storage.
- LPG also requires adaptations to the vehicle engines or the installation of dedicated LPG engines and the installation of dedicated fuel tanks.

## Different Refining Configurations Related To Automotive Fuel Qualities

A refinery's configuration refers to the type, size, number of process technologies and facilities employed, and the flow sequence.

Refinery configurations depend on what crude oil quality, product mix and quality, and environmental, safety, economic or other constraints were specified with its design. No two refineries are exactly alike, but refineries can be characterized into generic groups defined by the availability of the technologies.

A refinery's complexity is typically referred to within four configurations.

These configurations are listed in the table below together with their available process technologies and their yields.

## Refining Configurations and Their Yields

Configuration Group & Process Technologies	Product & Yield (vol %)				Comments
	Gas	Gasoline	Diesel	Fuel Oil	
<b>Topping</b> <ul style="list-style-type: none"> <li>• Crude Distillation</li> </ul>	2	32	30	37	<ul style="list-style-type: none"> <li>• Product quality and volume is dependent on crude oil source.</li> <li>• Distillate contains lots of heavy products.</li> <li>• Gasoline has low octane value.</li> </ul>
<b>Hydroskimming</b> <ul style="list-style-type: none"> <li>• Crude distillation</li> <li>• Hydrotreating</li> <li>• Reforming</li> </ul>	3	28	30	37	<ul style="list-style-type: none"> <li>• Product quality and volume is dependent on crude oil source. It allows refiners to adjust product slate (gasoline instead of naphtha).</li> <li>• Provides new possibilities to improve fuel quality, especially for gasoline.</li> <li>• Sulphur removal.</li> </ul>
<b>Conversion</b> <ul style="list-style-type: none"> <li>• Crude distillation</li> <li>• Hydrotreating</li> <li>• Reforming</li> <li>• FCC</li> <li>• Some upgrade units</li> </ul>	3	49	30	17	<ul style="list-style-type: none"> <li>• Flexibility in final production.</li> <li>• High quality products.</li> </ul>
<b>Deep Conv/Complex</b> <ul style="list-style-type: none"> <li>• Crude distillation</li> <li>• Hydrotreating</li> <li>• reforming</li> <li>• FCC</li> <li>• Many upgrade units</li> </ul>	3	47	43	4	<ul style="list-style-type: none"> <li>• Addition of coking allows minimal production of low valued fuel oil.</li> </ul>

## Refining Process Technologies

Refineries are comprised of a number of individual technology based processing facilities with varying objectives, and integrated as necessary to meet product targets.

The types, size, number and flow sequence of a specific refinery (i.e., refinery configuration) will vary depending on crude oil quality, required product mix and quality, and environmental, safety, economic or other constraints.

The major refinery processing steps or technologies can be categorized into six functional areas:

[separation,](#)

[conversion or cracking,](#)

[combination,](#)

[reformulation,](#)

[treating and other specialty or support operations.](#)

All these steps and technologies are included in the figure below that illustrates a complex refinery configuration.

# Refinery Flow Diagram

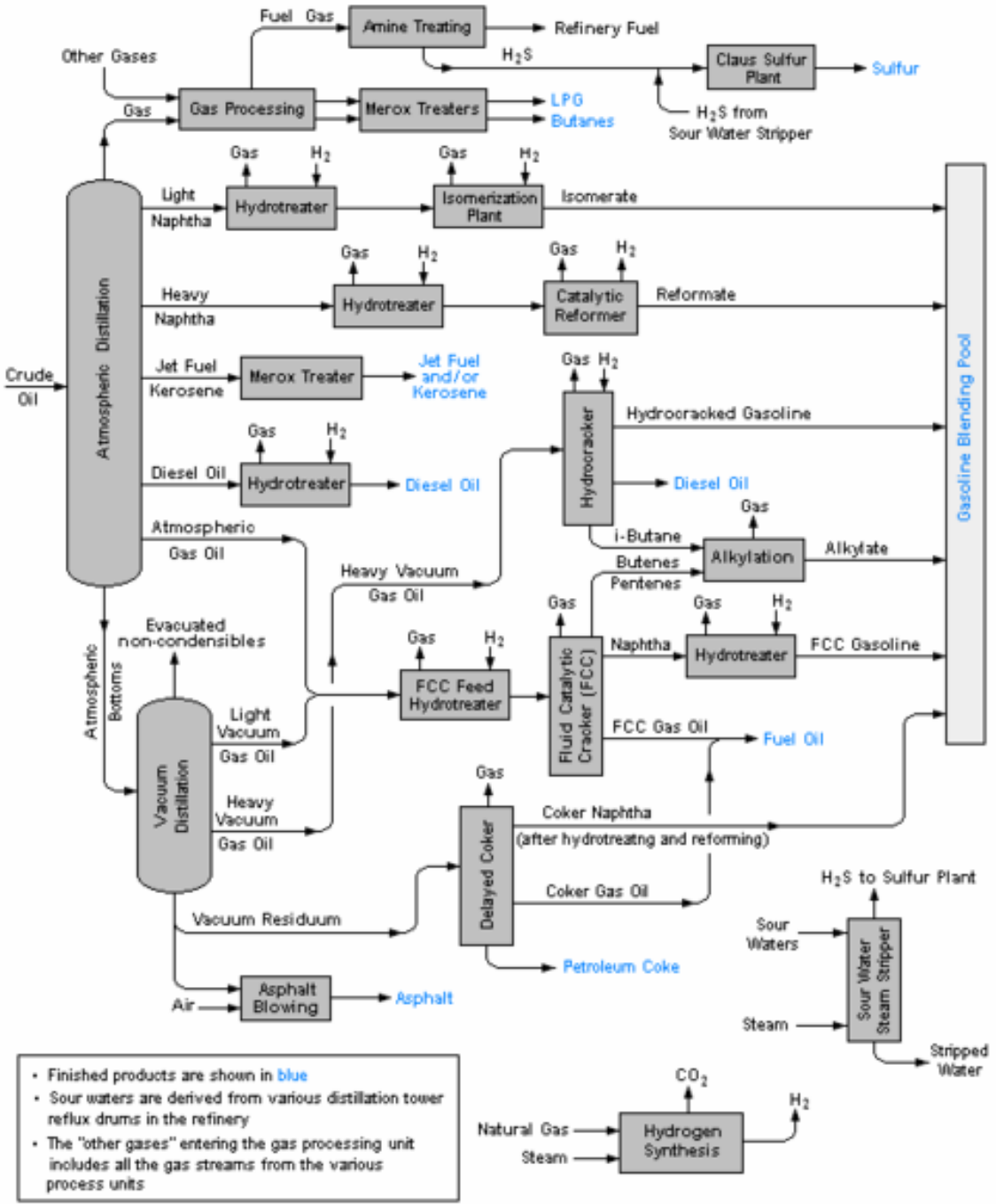

- Finished products are shown in blue
- Sour waters are derived from various distillation tower reflux drums in the refinery
- The "other gases" entering the gas processing unit includes all the gas streams from the various process units





# Hydrogen Applications in Refineries

Hydrogen demand will increase in the upcoming years as a result of stricter environmental legislation, more extensive processing of residues and higher diesel demand compared with gasoline.

There are various hydrotreating processes in a refinery.

To name only a few of them:

- **Hydrodesulfurization**: sulfur compounds are hydrogenated to hydrogen sulfide  $H_2S$  as feed for Claus plants
- **Hydroisomerization**: normal paraffins are converted into iso-paraffins to improve the product properties (e.g. RON)
- **Dearomatization**: aromatics are hydrogenated to cycloparaffins or alkanes
- **Hydrocracking**: long-chain hydrocarbons are cracked to shorter chains in the gasoline range

# Hydrogen Applications in Refineries

Basic flow diagram of a refinery

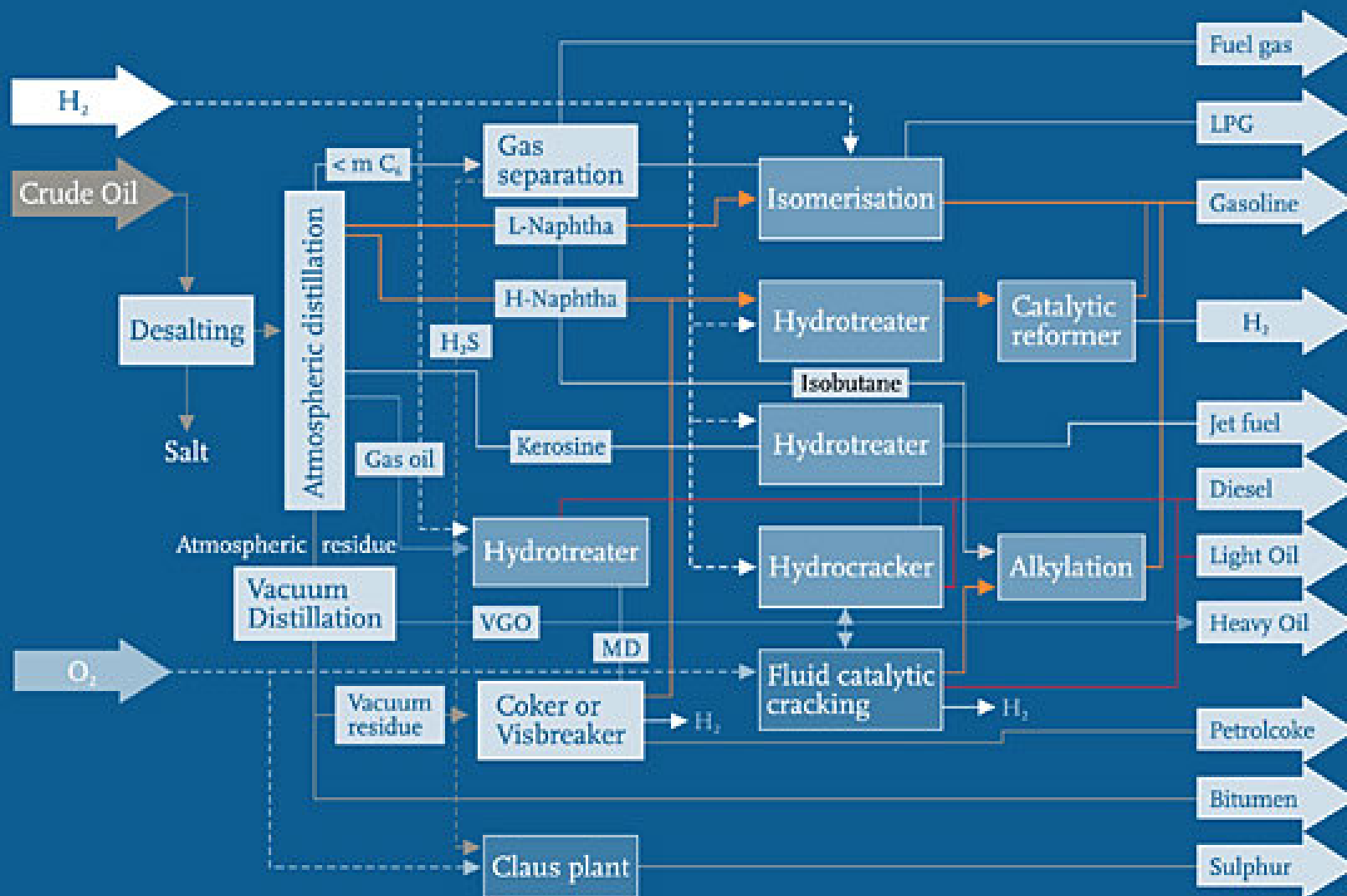

# Hydrogen Applications in Refineries

Hydrogen volumes consumed increasingly exceed those produced in a platformer (reforming) and have to be supplemented by other sources.

## Main processes for hydrogen on-site supply:

- Steam reforming of methane or other hydrocarbons
- Recovery from refinery off-gases
- Recovery from syngas
- Gasification of oil refining residues

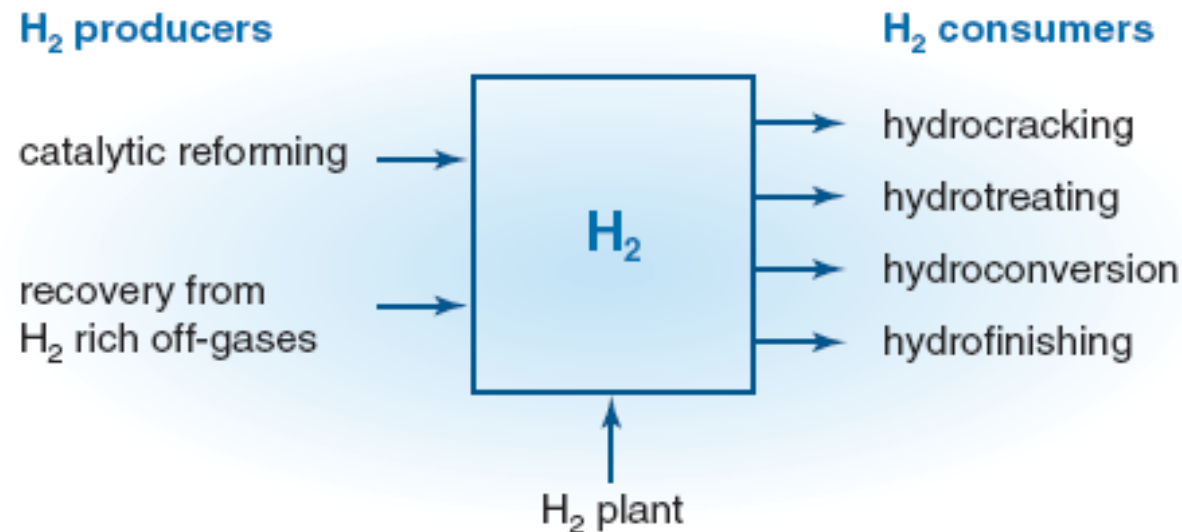

Schematic of refinery hydrogen balance.

# Hydrogen production

- currently the dominant technology for direct production is steam reforming (partial oxidation, gasification) from hydrocarbons; other methods: electrolysis, thermolysis...

## Hydrogen production processes

- **Steam Methane Reforming**
- **Coal Gasification**
- **Partial Oxidation of Hydrocarbons**
- Biomass Gasification
- Biomass Pyrolysis
- Electrolysis
- Thermochemical
- Photochemical
- Photobiological



- 48 % from natural gas (steam reforming)
- 30 % from oil (partial oxidation, gasification)
- 18 % from coal (gasification)
- 4 % from electrolysis of water

## Primary Uses for Hydrogen Today

- About half is used to produce ammonia ( $\text{NH}_3$ ) fertilizer.
- The other half of current hydrogen production is used to convert heavy petroleum sources into lighter fractions suitable for use as fuels.

# Hydrogen Applications in Petrochemical Industry

Hydrogen is widely used in the production of bulk chemicals, intermediates and speciality chemicals.

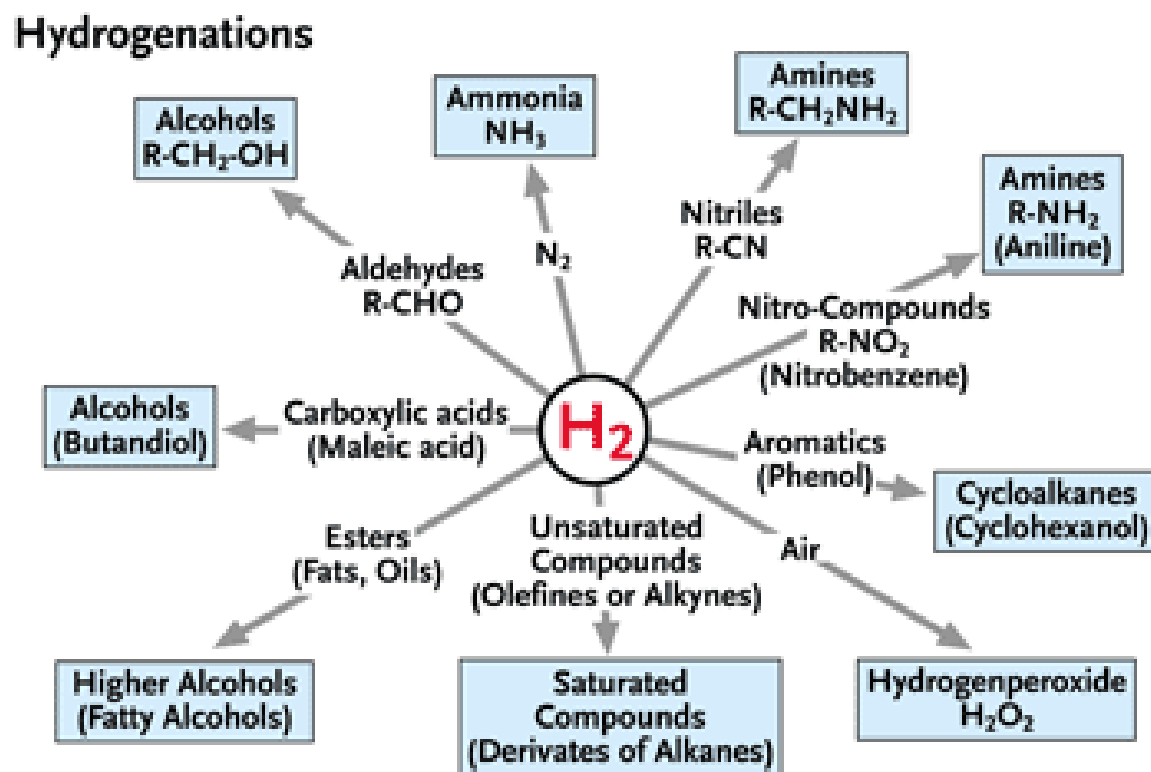

Mixtures of hydrogen and carbon monoxide, known as **syngas**, are fed to processes for large-scale production of methanol and various so-called oxo-products like higher alcohols and aldehydes.



# Hydrogen production

## Steam Methane Reforming

- most common method of producing commercial bulk hydrogen
  - most common method of producing hydrogen used in the industrial synthesis of ammonia
  - only light HC: methane, gasoline
  - it is the least expensive method
  - high temperature process: 700 – 1100 °C, pressure: 20 bar
  - nickel based catalyst (Ni / Al<sub>2</sub>O<sub>3</sub> + MgO)
- Process:
- (a) removal of catalytic poisons (S-compounds)
- (b) conversion of methane



# Hydrogen production

## Steam Methane Reforming Process

- at 700 – 1100 °C and in the presence of a nickel based catalyst (Ni), steam reacts with methane to yield carbon monoxide and hydrogen (syngas) :



- endothermic reaction (heat must be added to the reactants for the reaction to occur)
- side reactions:

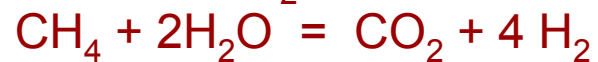

- additional hydrogen can be recovered by a lower-temperature gas-shift reaction with the carbon monoxide produced:



- carbon dioxide and other impurities are removed from the gas stream (usually using PSA method), leaving essentially pure hydrogen

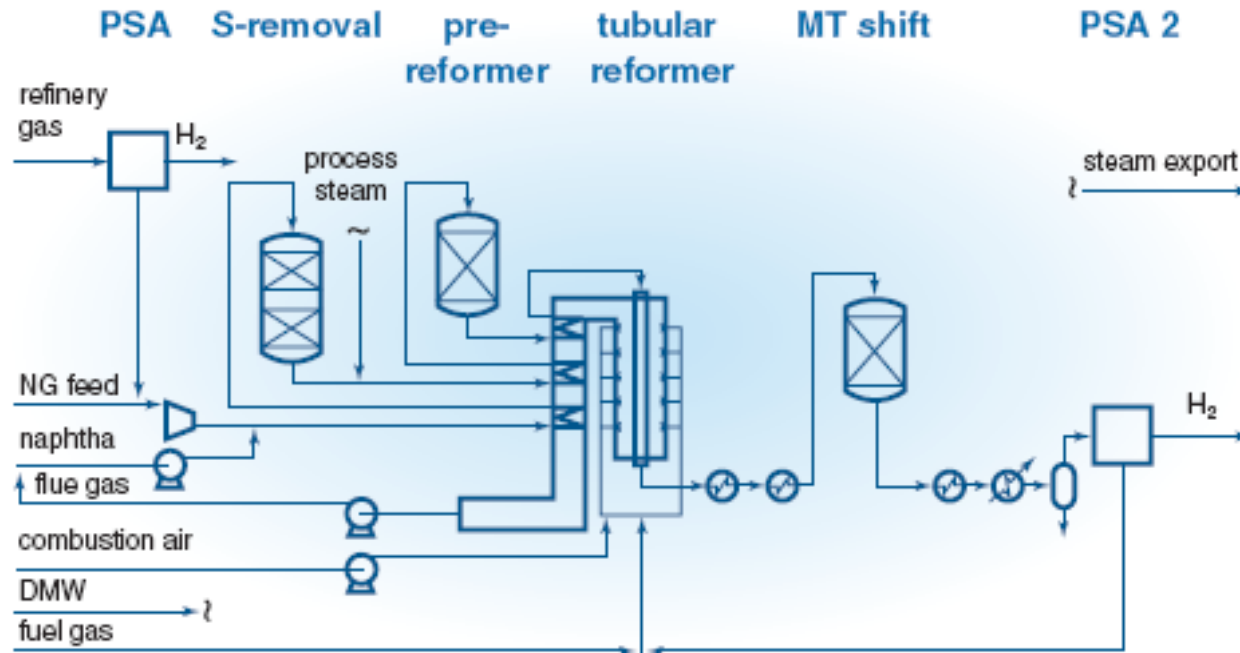

## Process lay-out of a typical multi feedstock H<sub>2</sub>-plant (Haldor Topsoe).

A typical *process lay-out* of a feedstock flexible hydrogen plant operating at 25 bar on refinery gas, natural gas and naphtha.

Refinery gas, containing large amounts of hydrogen, is sent to a **PSA unit** where pure hydrogen is extracted.

The off-gas from the PSA, containing non-converted methane, is compressed and used as feed in the hydrogen plant.

In this way, low grade refinery gas is used as feed to a hydrogen plant and thereby substituting more expensive natural gas or naphtha. PSA off-gas is mixed with natural gas or vaporized naphtha, and the gas mixture is preheated, **desulfurized**

(over **CoMo-catalyst and ZnO**), mixed with process steam and further heated before entering the adiabatic prereformer.

Typical inlet temperatures are in the range 450–550 °C, depending on feedstock and the steam to carbon ratio.

The prereformed gas is then heated to 650 °C before entering the **tubular reformer** where final conversion to equilibrium of methane into hydrogen, carbon monoxide and carbon dioxide takes place at 850–950 °C, depending on lay-out.

The reformed gas is cooled by producing steam before entering the **shift converter**, typically containing a **medium temperature shift (MTS)** (210–330 °C). Over the **copper-based shift catalyst**, more hydrogen is produced by the conversion of carbon monoxide and steam to carbon dioxide and hydrogen. The shifted gas is cooled to ambient temperature before entering

the **second PSA unit**. The off-gas from this PSA unit is used as fuel in the tubular reformer supplemented with fuel gas.

## Membrane reforming hydrogen plant with CO<sub>2</sub> sequestration.

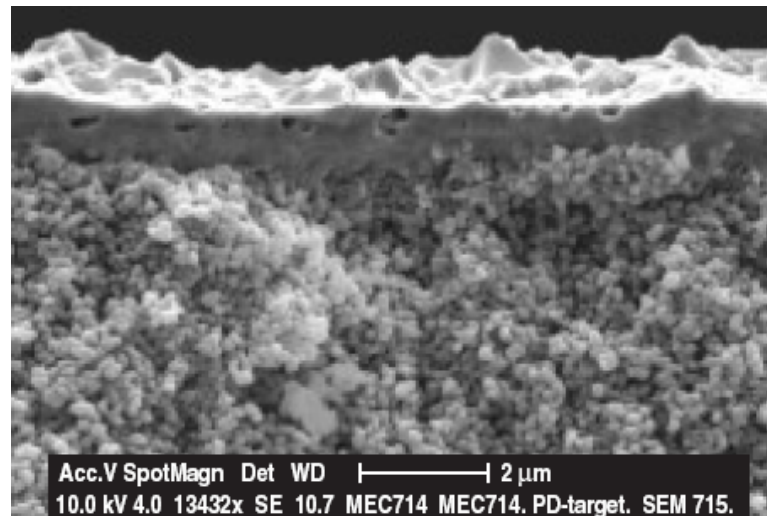
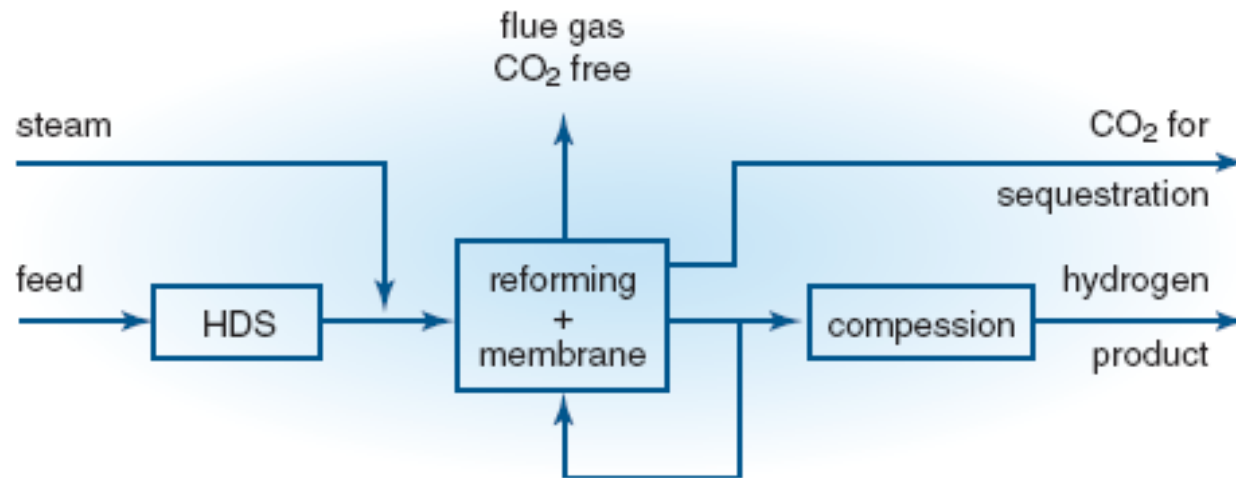

Palladium Membrane. A micron thin palladium film is deposited on a functionally designed ceramic support tube.

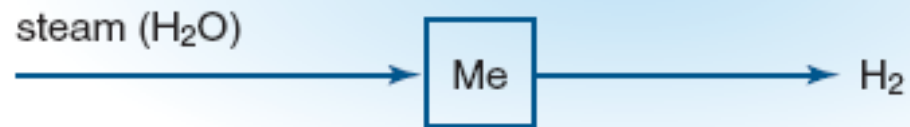

Cyclic process for CO<sub>2</sub>-free hydrogen.  
Me = metal.



# Hydrogen production

## Partial Oxidation

- methane and other hydrocarbons in natural gas are reacted with a limited amount of oxygen (typically, from air) that is not enough to completely oxidize the hydrocarbons to carbon dioxide and water
- raw material: fuel oil, distillation residues, oil (high content of S-compounds)
- process conditions: 1200...1500 °C, 30...80 bar (without catalysts)

- main reactions:

1) partial oxidation (exothermic reaction,  $\Delta H = -$ ):



2) hydration ( $\Delta H = +$ ):



- side reactions

1) coke formation

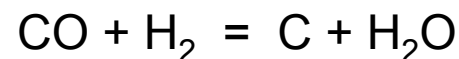
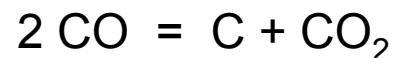

2) complete oxidation

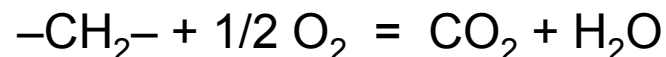

## Autothermal reforming process

For very large grass root hydrogen plants (in excess of about 200,000 Nm<sup>3</sup> H<sub>2</sub>/h), the different economies of scale with respect to tubular reformers and oxygen plants may favor the use of oxygen for partial oxidation of the hydrocarbon feed as practiced in the **autothermal reforming process**:

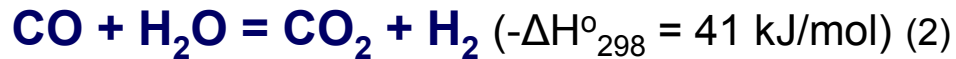
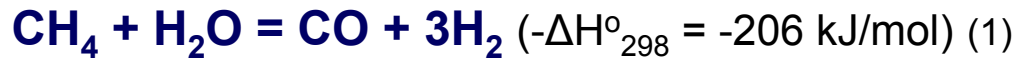

In the autothermal reforming process, the feedstock is reacted with a mixture of oxygen and steam by the use of a burner and a fixed nickel catalyst bed for the equilibration (reactions (1) and (2)) of the gas.

This results in a lower oxygen consumption,  $\text{O}_2/\text{CH}_4 = 0.5\text{--}0.6$ , than used in non-catalytic routes.

With the addition of steam, it is possible to adjust the H<sub>2</sub>/CO ratio.

This cannot be achieved by non-catalytic routes because the addition of steam results in a reduction of temperature and soot formation.

On the other hand, the non-catalytic routes are the only technologies available for gasification of resid and at the non-distillate fuels.

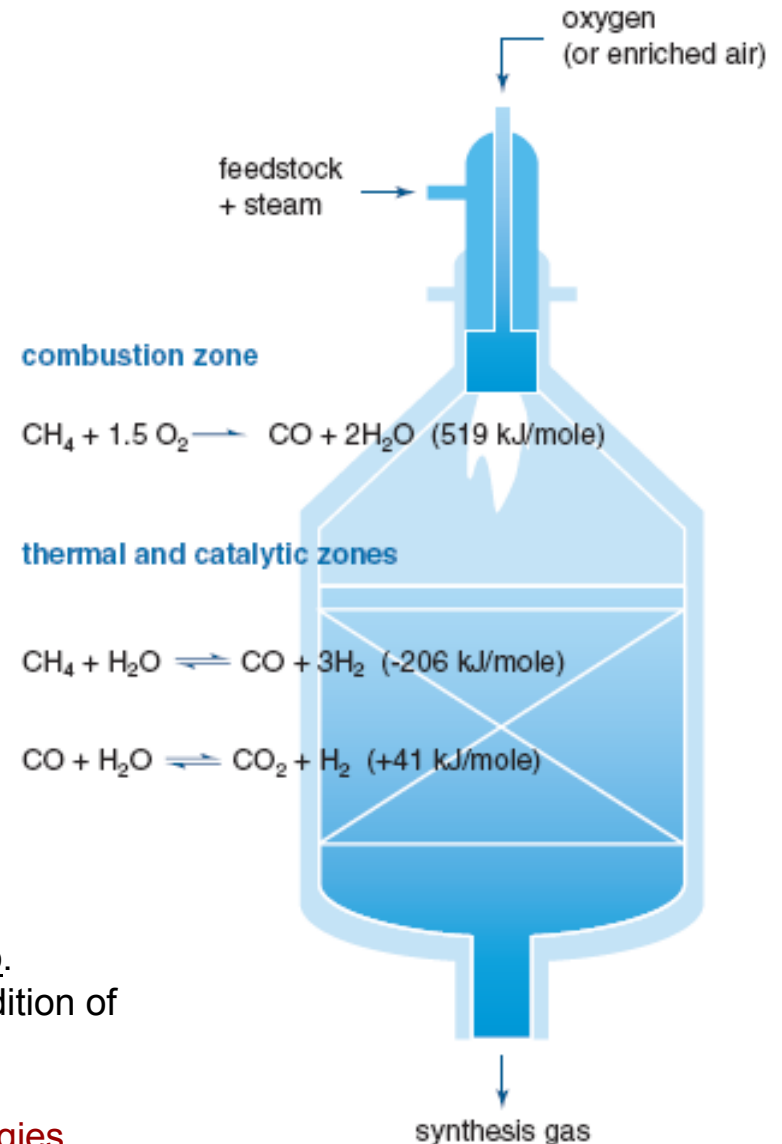

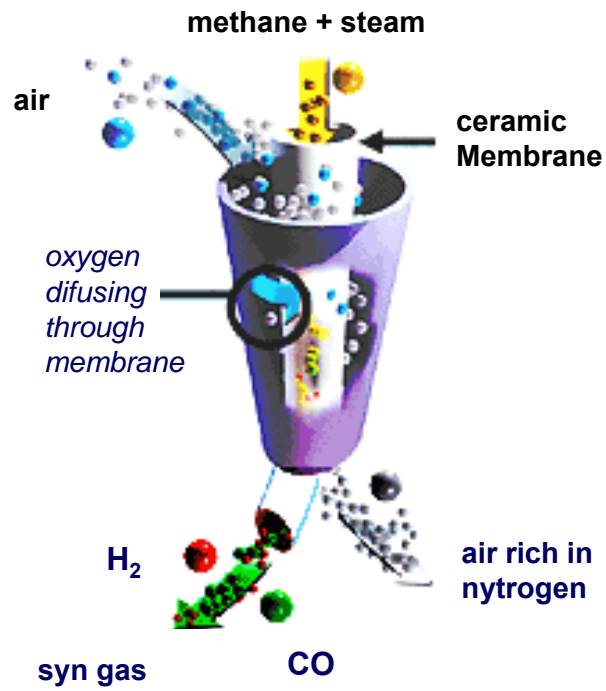

## Future technology development

- using of air instead of pure oxigen, O<sub>2</sub>

# Hydrogen production

## Coal Gasification

- well-established commercial technology (up to 1960. most common; nowadays: IGCC)
- competitive with SMR only where oil and/or natural gas are expensive
- coal could replace natural gas and oil as the primary feedstock for hydrogen production, since it is so plentiful in the world
- Reaction temperature: 900 – 1000 °C

Main reactions:

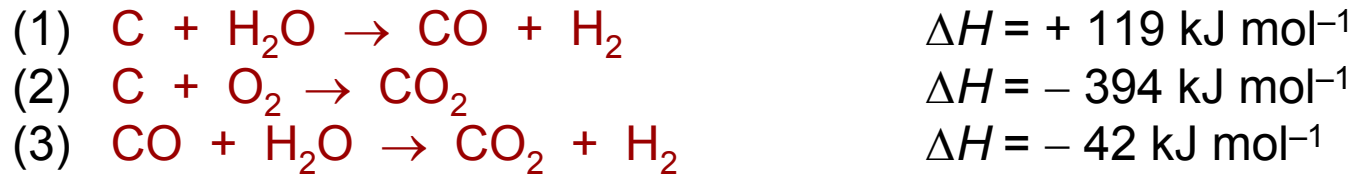

## Project FutureGen

"Today I am pleased to announce that the United States will sponsor a **\$1 billion**, 10-year demonstration project to create the world's first **coal-based, zero-emissions electricity and hydrogen power plant...**"



*George W. Bush*  
2003.

...2008.

“Instead, the DOE hopes to help industry add **carbon-capture-and-storage capability** to advanced coal plants already in the works.”

## Composition of syngas in dependence on raw material type and process of production

Raw material (process)	Syngas Composition					
	H <sub>2</sub>	CO	H <sub>2</sub> / CO	CO <sub>2</sub>	N <sub>2</sub> + Ar	CH <sub>4</sub>
Methane (steam reforming)	75.7	15.5	5	8.1	0.2	0.5
Gas Oil (partial oxidation)	46.7	47.3	1	4.3	1.4	0.3
Coal (gasification)	31	68	0.5	1.0	-	-

## Hydrogen Processes in Refineries

**Hydrodesulfurization (HDS)** is a *catalytic chemical process* widely used to remove sulfur (S) from natural gas and from refined petroleum products such as gasoline or petrol, jet fuel, kerosene, diesel fuel, and fuel oils.

The purpose of removing the sulfur is **to reduce the sulfur dioxide emissions** that result from using those fuels in automotive vehicles, aircraft, railroad locomotives, ships, gas or oil burning power plants, residential and industrial furnaces, and other forms of fuel combustion.

Another important reason for removing sulfur from the naphtha streams within a petroleum refinery is that **sulfur**, even in extremely low concentrations, **poisons the noble metal catalysts** (platinum and rhenium) in the *catalytic reforming units* that are subsequently used to upgrade the octane rating of the naphtha streams.

The industrial hydrodesulfurization processes include facilities for the capture and removal of the resulting hydrogen sulfide gas. In petroleum refineries, the hydrogen sulfide gas is then subsequently converted into byproduct elemental sulfur or sulfuric acid.

An HDS unit in the petroleum refining industry is also often referred to as a hydrotreater.



# Hydrogen Processes in Refineries

## Hydrodesulfurization (HDS)

### The process chemistry

**Hydrogenation** is a class of chemical reactions in which the net result is the addition of hydrogen (H). **Hydrogenolysis** is a type of hydrogenation and results in the cleavage of the C-X chemical bond, where C is a carbon atom and X is a sulfur, nitrogen (N) or oxygen (O) atom. The net result of a hydrogenolysis reaction is the formation of C-H and H-X chemical bonds.

Thus, hydrodesulfurization is a hydrogenolysis reaction.

Using ethanethiol (C<sub>2</sub>H<sub>5</sub>SH), a sulfur compound present in some petroleum products, as an example, the hydrodesulfurization reaction can be simply expressed as



# Hydrogen Processes in Refineries

## Hydrodesulfurization (HDS)

### Catalysts and mechanisms

The main HDS catalysts are based on molybdenum disulfide ( $\text{MoS}_2$ ) together with smaller amounts of other metals.

At the edges of the  $\text{MoS}_2$  crystallites, the molybdenum centre can stabilize a coordinatively unsaturated site (CUS), also known as an anion vacancy.

Substrates, such as thiophene, bind to this site and undergo a series of reactions that result in both C-S scission and C=C hydrogenation. Thus, the hydrogen serves multiple roles - generation of anion vacancy by removal of sulfide, hydrogenation, and hydrogenolysis. A simplified diagram for the cycle is shown:

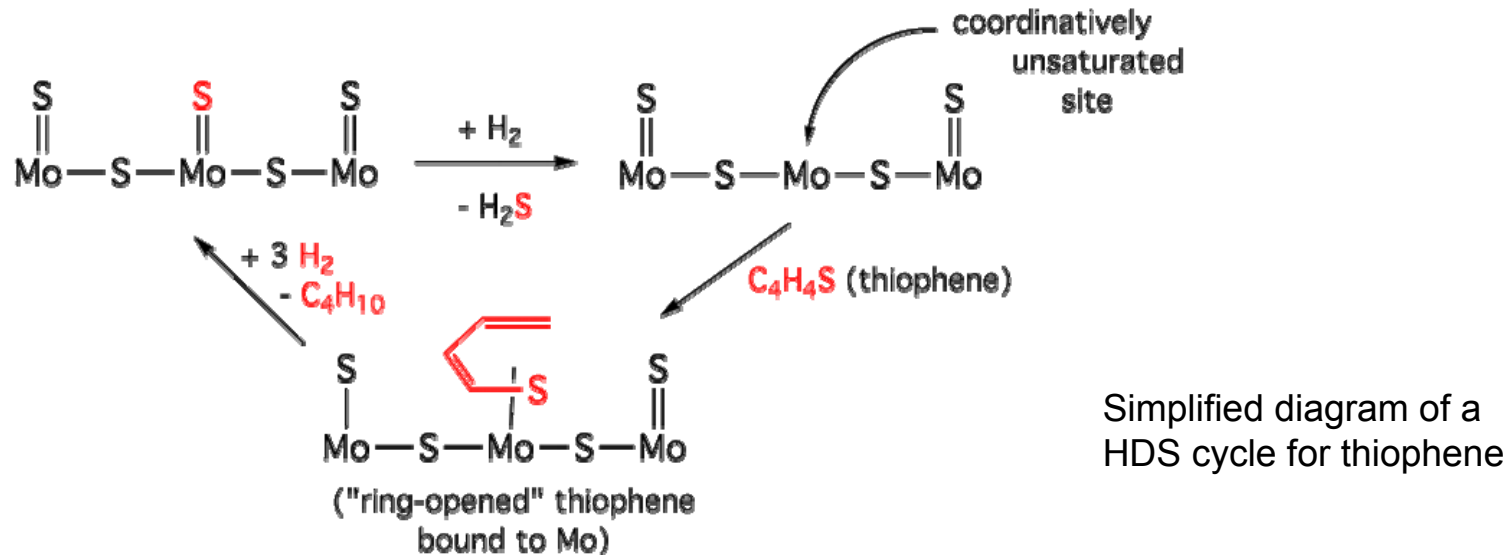

Most metals catalyse HDS, but it is those at the middle of the transition metal series that are most active.

**Ruthenium disulfide** appears to be the single most active catalyst, but binary combinations of **Co-Mo** are also highly active.

Aside from the basic cobalt-modified  $\text{MoS}_2$  catalyst, nickel and tungsten are also used, depending on the nature of the feed.

For example, **Ni-W** catalysts are more effective for hydrodenitration (HDN).

Metal sulfides are "supported" on materials with high surface areas. A typical support for HDS catalyst is  $\gamma$ -alumina.

The support allows the more expensive catalyst to be more widely distributed, giving rise to a larger fraction of the  $\text{MoS}_2$  that is catalytically active. The interaction between the support and the catalyst is an area of intense interest, since the support is often not fully inert but participates in the catalysis.

# Hydrogen Processes in Refineries

## Hydrodesulfurization (HDS)

### Hydrodenitrogenation

The hydrogenolysis reaction is also used to reduce the nitrogen content of a petroleum stream in a process referred to as hydrodenitrogenation (HDN). The process flow is the same as that for an HDS unit.

Using pyridine ( $C_5H_5N$ ), a nitrogen compound present in some petroleum fractionation products, as an example, the hydrodenitrogenation reaction has been postulated as occurring in three steps:

Pyridine + Hydrogen → Piperidine + Hydrogen → Amylamine + Hydrogen → Pentane + Ammonia



Many HDS units for desulfurizing naphthas within petroleum refineries are actually simultaneously denitrogenating to some extent as well.

### Saturation of olefins

The hydrogenolysis reaction may also be used to saturate or convert olefins (alkenes) into paraffins (alkanes). The process used is the same as for an HDS unit.

Pentene + Hydrogen → Pentane

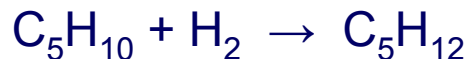

Some hydrogenolysis units within a petroleum refinery or a petrochemical plant may be used solely for the saturation of olefins or they may be used for simultaneously desulfurizing as well as denitrogenating and saturating olefins to some extent.

# Hydrogen Processes in Refineries

## Hydrodesulfurization (HDS)

### Process description

In an industrial hydrodesulfurization unit, such as in a refinery, the hydrodesulfurization reaction takes place in a fixed-bed reactor at elevated temperatures ranging from 300 to 400 °C and elevated pressures ranging from 30 to 130 atmospheres of absolute pressure, typically in the presence of a catalyst consisting of an alumina base impregnated with cobalt and molybdenum (usually called a CoMo catalyst). Occasionally, a combination of nickel and molybdenum (called NiMo) is used, in addition to the CoMo catalyst, for specific difficult-to-treat feed stocks, such as those containing a high level of chemically bound nitrogen.

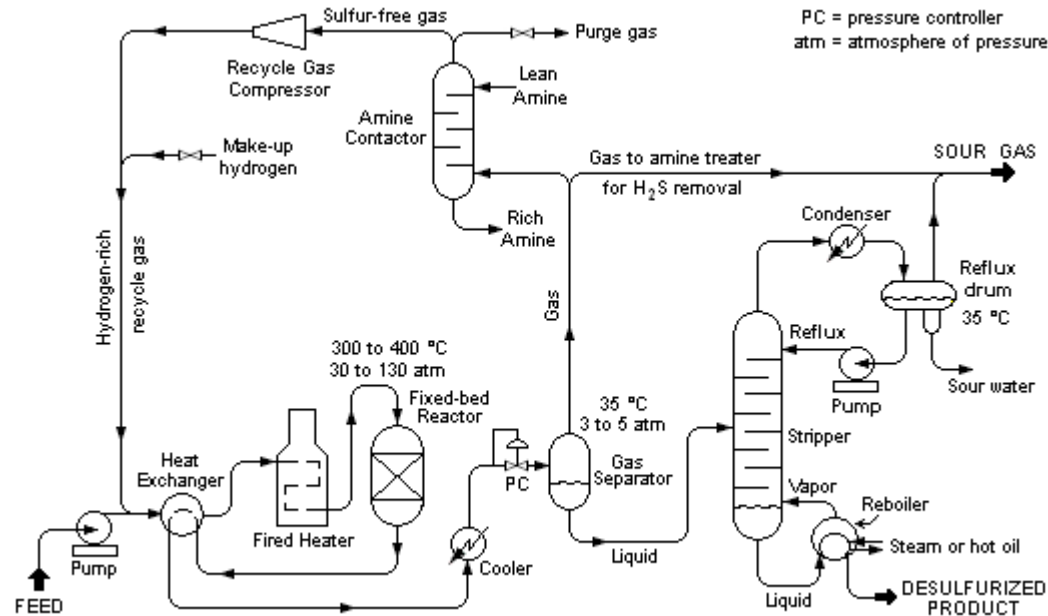

Schematic diagram of a typical Hydrodesulfurization (HDS) unit in a petroleum refinery

# Hydrogen Processes in Refineries

## Hydrodesulfurization (HDS)

### Process description

The liquid feed (at the bottom left in the diagram) is pumped up to the required elevated pressure and is joined by a stream of hydrogen-rich recycle gas. The resulting liquid-gas mixture is preheated by flowing through a heat exchanger. The preheated feed then flows through a fired heater where the feed mixture is totally vaporized and heated to the required elevated temperature before entering the reactor and flowing through a fixed-bed of catalyst where the hydrodesulfurization reaction takes place.

The hot reaction products are partially cooled by flowing through the heat exchanger where the reactor feed was preheated and then flows through a water-cooled heat exchanger before it flows through the pressure controller (PC) and undergoes a pressure reduction down to about 3 to 5 atmospheres. The resulting mixture of liquid and gas enters the gas separator vessel at about 35 °C and 3 to 5 atmospheres of absolute pressure.

Most of the hydrogen-rich gas from the gas separator vessel is recycle gas, which is routed through an amine contactor for removal of the reaction product H<sub>2</sub>S that it contains. The H<sub>2</sub>S-free hydrogen-rich gas is then recycled back for reuse in the reactor section. Any excess gas from the gas separator vessel joins the sour gas from the stripping of the reaction product liquid.

The liquid from the gas separator vessel is routed through a reboiled stripper distillation tower. The bottoms product from the stripper is the final desulfurized liquid product from hydrodesulfurization unit.

The overhead sour gas from the stripper contains hydrogen, methane, ethane, hydrogen sulfide, propane, and, perhaps, some butane and heavier components. That sour gas is sent to the refinery's central gas processing plant for removal of the hydrogen sulfide in the refinery's main amine gas treating unit and through a series of distillation towers for recovery of propane, butane and pentane or heavier components. The residual hydrogen, methane, ethane, and some propane is used as refinery fuel gas. The hydrogen sulfide removed and recovered by the amine gas treating unit is subsequently converted to elemental sulfur in a Claus process unit or to sulfuric acid in a wet sulfuric acid process or in the conventional Contact Process.

Note that the above description assumes that the HDS unit feed contains no olefins. If the feed does contain olefins (for example, the feed is a naphtha derived from a refinery fluid catalytic cracker (FCC) unit), then the overhead gas from the HDS stripper may also contain some ethene, propene, butenes and pentenes, or heavier components.

It should also be noted that the amine solution to and from the recycle gas contactor comes from and is returned to the refinery's main amine gas treating unit.

# Hydrogen Processes in Refineries

## Hydrodesulfurization (HDS)

### Amine gas treating

Amine gas treating, also known as gas sweetening and acid gas removal, refers to a group of processes that use aqueous solutions of various alkylamines (commonly referred to simply as amines) to remove hydrogen sulfide (H<sub>2</sub>S) and carbon dioxide (CO<sub>2</sub>) from gases. It is a common unit process used in refineries, and is also used in petrochemical plants, natural gas processing plants and other industries.

Processes within oil refineries or chemical processing plants that remove hydrogen sulfide and/or mercaptans are commonly referred to as sweetening processes because they result in products which no longer have the sour, foul odors of mercaptans and hydrogen sulfide.

There are many different amines used in gas treating:

- Monoethanolamine (MEA) HO-CH2-CH2-NH2

- Diethanolamine (DEA)

- Methyldiethanolamine (MDEA)

- Diisopropylamine (DIPA)

- Aminoethoxyethanol (diglycolamine) (DGA)

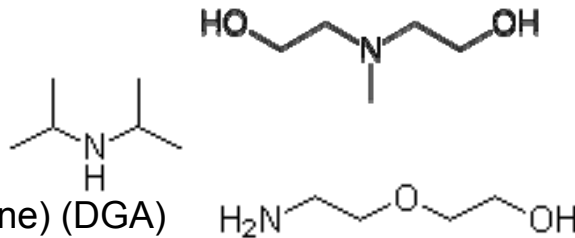

The most commonly used amines in industrial plants are the alkanolamines MEA, DEA, and MDEA.

Amines are also used in many oil refineries to remove sour gases from liquid hydrocarbons such as liquified petroleum gas (LPG).

# Hydrogen Processes in Refineries

## Hydrodesulfurization (HDS)

### Amine gas treating

Gases containing H<sub>2</sub>S or both H<sub>2</sub>S and CO<sub>2</sub> are commonly referred to as sour gases or acid gases in the hydrocarbon processing industries.

For one of the more common amines, methanolamine (MEA) denoted as RNH<sub>2</sub>, the chemistry may be simply expressed as:



# Hydrogen Processes in Refineries

## Hydrodesulfurization (HDS)

### Amine gas treating

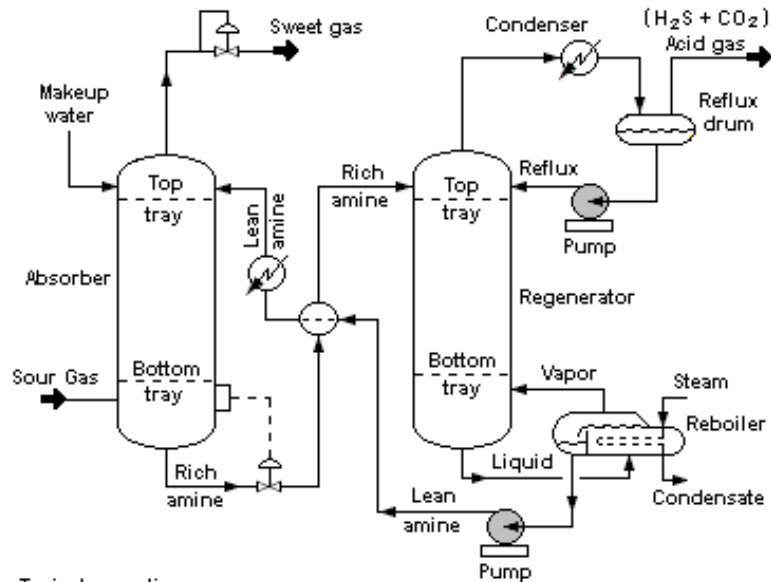

#### Typical operating ranges

Absorber : 35 to 50 °C and 5 to 205 atm of absolute pressure  
 Regenerator : 115 to 126 °C and 1.4 to 1.7 atm of absolute pressure  
 at tower bottom

A typical amine gas treating process includes an absorber unit and a regenerator unit as well as accessory equipment.

In the absorber, the downflowing amine solution absorbs  $H_2S$  and  $CO_2$  from the upflowing sour gas to produce a sweetened gas stream (i.e., an  $H_2S$ -free gas) as a product and an amine solution rich in the absorbed acid gases. The resultant "rich" amine is then routed into the regenerator (a stripper with a reboiler) to produce regenerated or "lean" amine that is recycled for reuse in the absorber. The stripped overhead gas from the regenerator is concentrated  $H_2S$  and  $CO_2$ .

In oil refineries, that stripped gas is mostly  $H_2S$ , much of which often comes from a sulfur-removing process called hydrodesulfurization. This  $H_2S$ -rich stripped gas stream is then usually routed into a Claus process to convert it into elemental sulfur.

Another sulfur-removing process is the WSA Process which recovers sulfur in any form as concentrated sulfuric acid. In some plants, more than one amine absorber unit may share a common regenerator unit.



# Hydrogen Processes in Refineries

## Hydrodesulfurization (HDS)

### Claus process

The Claus process is the most significant gas desulfurizing process, recovering elemental sulfur from gaseous hydrogen sulfide. First patented in 1883 by the scientist Carl Friedrich Claus, the Claus process has become the industry standard.

The multi-step Claus process recovers sulfur from the gaseous hydrogen sulfide found in raw natural gas and from the by-product gases containing hydrogen sulfide derived from refining crude oil and other industrial processes. The by-product gases mainly originate from physical and chemical gas treatment units (Selexol, Rectisol, Purisol and amine scrubbers) in refineries, natural gas processing plants and gasification or synthesis gas plants. These by-product gases may also contain hydrogen cyanide, hydrocarbons, sulfur dioxide or ammonia.

Gases with an H<sub>2</sub>S content of over 25% are suitable for the recovery of sulfur in straight-through Claus plants while alternate configurations such as a split-flow set up or feed and air preheating can be used to process leaner feeds.

Hydrogen sulfide produced, for example, in the hydro-desulfurization of refinery naphthas and other petroleum oils, is converted to sulfur in Claus plants. The overall main reaction equation is:



In fact, the vast majority of the 64,000,000 metric tons of sulfur produced worldwide in 2005 was byproduct sulfur from refineries and other hydrocarbon processing plants. Sulfur is used for manufacturing sulfuric acid, medicine, cosmetics, fertilizers and rubber products. Elemental sulfur is used as fertilizer and pesticide.

# Hydrogen Processes in Refineries

## Hydrodesulfurization (HDS)

### Claus process

#### Process description

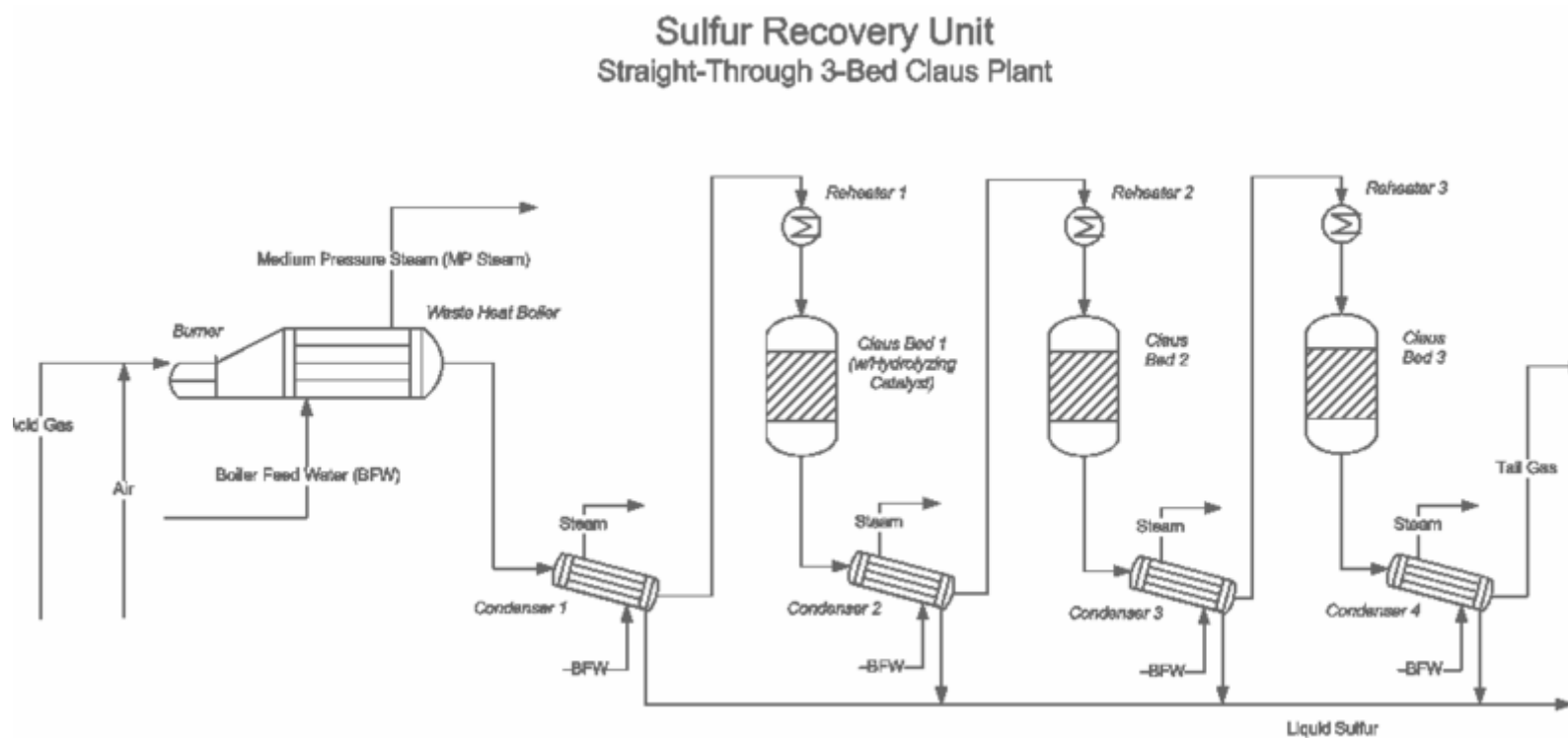

The Claus technology can be divided into two process steps, thermal and catalytic.

# Hydrogen Processes in Refineries

## Hydrodesulfurization (HDS)

### Claus process

1. In the thermal step, hydrogen sulfide-laden gas reacts in a substoichiometric combustion at temperatures above 850 °C such that elemental sulfur precipitates in the downstream process gas cooler.

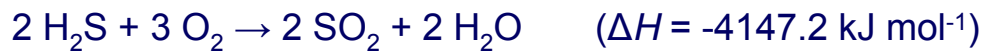

This is a strongly exothermic free-flame total oxidation of hydrogen sulfide generating sulfur dioxide that reacts away in subsequent reactions. The most important one is the Claus reaction:

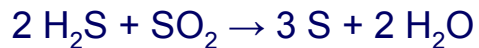

The overall equation is:



This equation shows that in the thermal step alone two-thirds of the hydrogen sulfide is converted to sulfur.

Gases containing ammonia, such as the gas from the refinery's sour water stripper (SWS), or hydrocarbons are converted in the burner muffle. Sufficient air is injected into the muffle for the complete combustion of all hydrocarbons and ammonia. The air to the acid gas ratio is controlled such that in total 1/3 of all hydrogen sulfide (H<sub>2</sub>S) is converted to SO<sub>2</sub>. This ensures a stoichiometric reaction for the Claus reaction in the second catalytic step.

The separation of the combustion processes ensures an accurate dosage of the required air volume needed as a function of the feed gas composition. To reduce the process gas volume or obtain higher combustion temperatures, the air requirement can also be covered by injecting pure oxygen.

Usually, 60 to 70% of the total amount of elemental sulfur produced in the process are obtained in the thermal process step.

The sulfur forms in the thermal phase as highly reactive S<sub>2</sub> diradicals which combine exclusively to the S<sub>8</sub> allotrope:

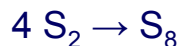

# Hydrogen Processes in Refineries

## Hydrodesulfurization (HDS)

### Claus process

Other chemical processes taking place in the thermal step of the Claus reaction are:

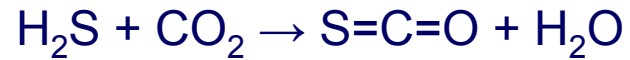
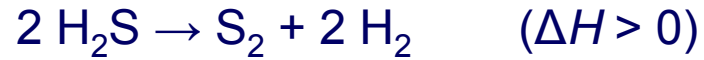

# Hydrogen Processes in Refineries

## Hydrodesulfurization (HDS)

### Claus process

2. The Claus reaction continues in the catalytic step with activated aluminum (III) or titanium (IV) oxide, and serves **to boost the sulfur yield**. More hydrogen sulfide ( $\text{H}_2\text{S}$ ) reacts with the  $\text{SO}_2$  formed during combustion in the reaction furnace in the Claus reaction, and results in gaseous, elemental sulfur.

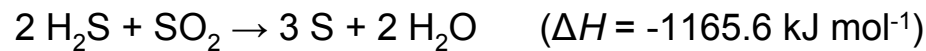

This sulfur can be  $\text{S}_6$ ,  $\text{S}_7$ ,  $\text{S}_8$  or  $\text{S}_9$ .

The catalytic recovery of sulfur consists of three substeps: heating, catalytic reaction and cooling plus condensation. These three steps are normally repeated a maximum of three times. Where an incineration or tail-gas treatment unit (TGTU) is added downstream of the Claus plant, only two catalytic stages are usually installed.

The typically recommended operating temperature of the first catalyst stage is  $315^\circ\text{C}$  to  $330^\circ\text{C}$  (bottom bed temperature). The high temperature in the first stage also helps to hydrolyze COS and  $\text{CS}_2$ , which is formed in the furnace and would not otherwise be converted in the modified Claus process.

The catalytic conversion is maximized at lower temperatures, but care must be taken to ensure that each bed is operated above the dew point of sulfur. The operating temperatures of the subsequent catalytic stages are typically  $240^\circ\text{C}$  for the second stage and  $200^\circ\text{C}$  for the third stage (bottom bed temperatures).

In the sulfur condenser, the process gas coming from the catalytic reactor is cooled to between  $150$  and  $130^\circ\text{C}$ . The condensation heat is used to generate steam at the shell side of the condenser.

Before storage, liquid sulfur streams from the process gas cooler, the sulfur condensers and from the final sulfur separator are routed to the degassing unit, where the gases (primarily  $\text{H}_2\text{S}$ ) dissolved in the sulfur are removed.

The tail gas from the Claus process still containing combustible components and sulfur compounds ( $\text{H}_2\text{S}$ ,  $\text{H}_2$  and CO) is either burned in an incineration unit or further desulfurized in a downstream tail gas treatment unit.



# Industrial catalysis

- about 90 % of all chemical processes use catalysts
- 15 - 20 % of GNP in industrially developed countries depends on catalysts
- essential for environmental protection, fuel upgrading and supply of chemicals
- many types of catalysts: metals, alloys, oxides, sulfides, zeolites etc.

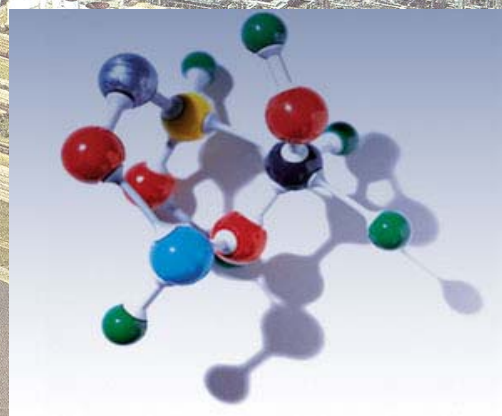



# Refinery

- catalysis is more important than ever:

high crude oil prices - small profit margin

(economic environment, EU refinig overcapacity, technology, maintenance, volume of products...)

- industrial catalysts are at the heart of refining processes and determine the way they will evolve in the future
- from the standpoint of value, refinig catalysts account for about 33 % of the world market, coming just after environmental protection catalysts (40 %)
- refinery of the 21<sup>st</sup> century – high-performance non-poluting processes
- more active, selective and stable catalysts with lower production cost

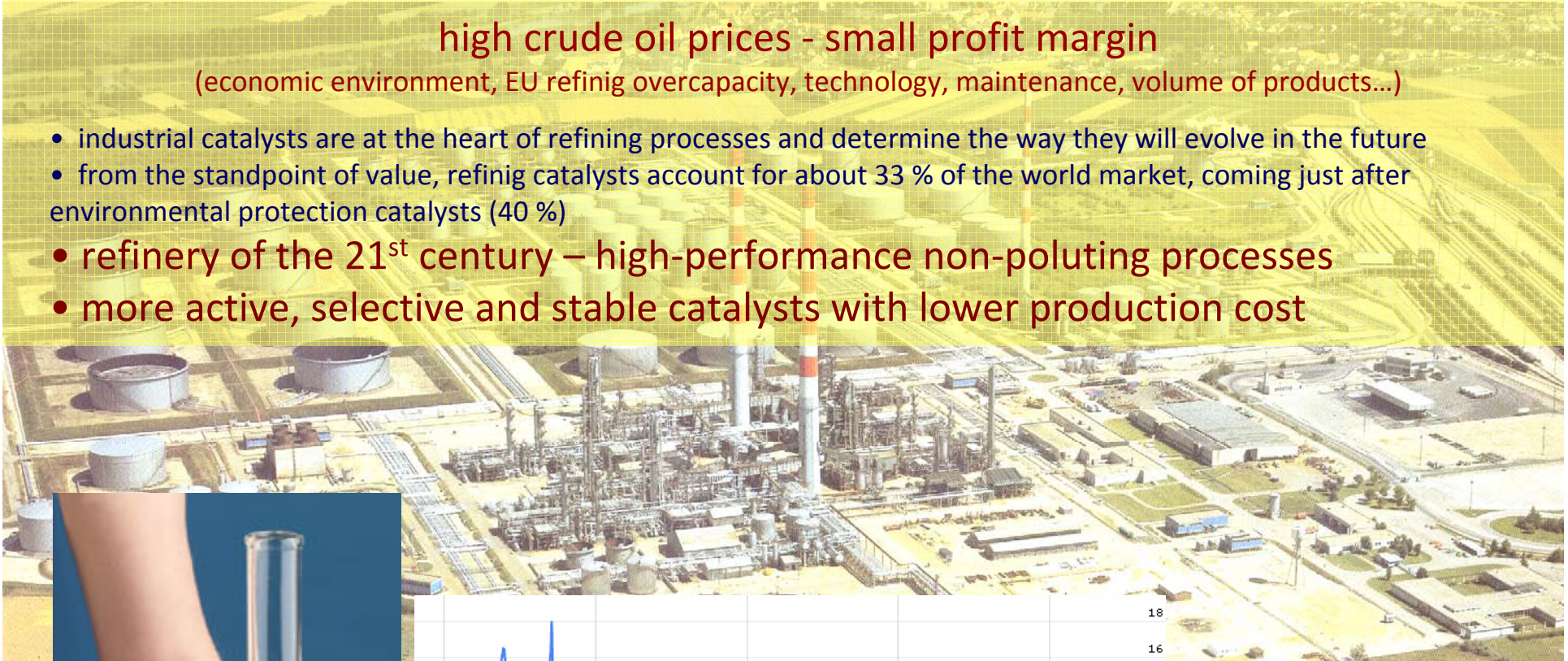

Neste Oil reference margin  
(USD/bbl)

# Nanocatalysis

- it is expected to revolutionize the way catalysts are developed and prepared
- ability to design and characterize new nano-materials and predict their catalytic capabilities
- nanoparticles have a large surface to volume ratio

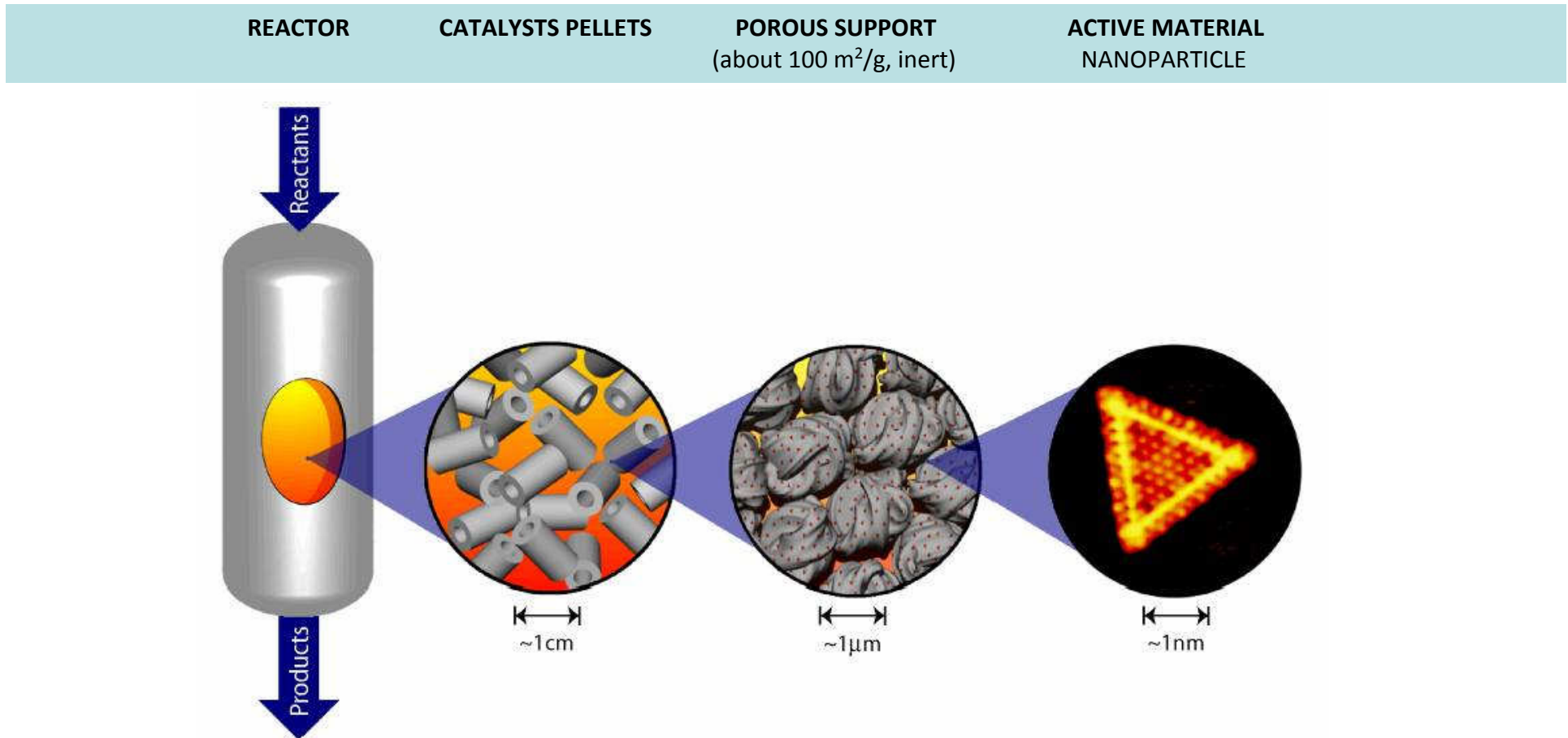

*The structure of a heterogeneous catalyst illustrating the length scales and complexity involved in a heterogeneous catalyst*



# HydroDeSulfurization Process (HDS)

Regulatory push sulphur in diesel requires more hydrotreating

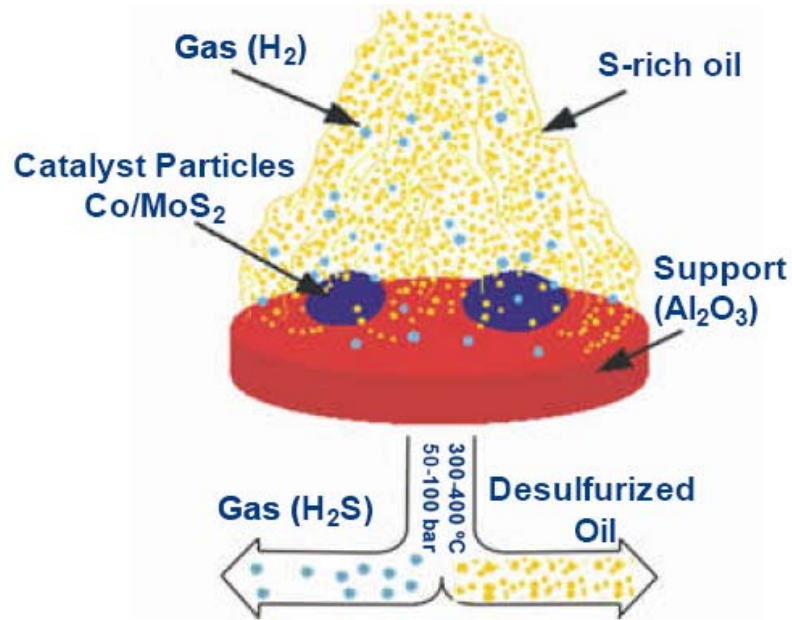

*In-situ* EXAFS measurements:  
single-layer MoS<sub>2</sub>-like, ~10-20 Å at 400 °C

## Nano-clusters of MoS<sub>2</sub>

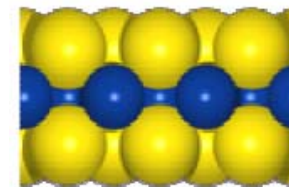
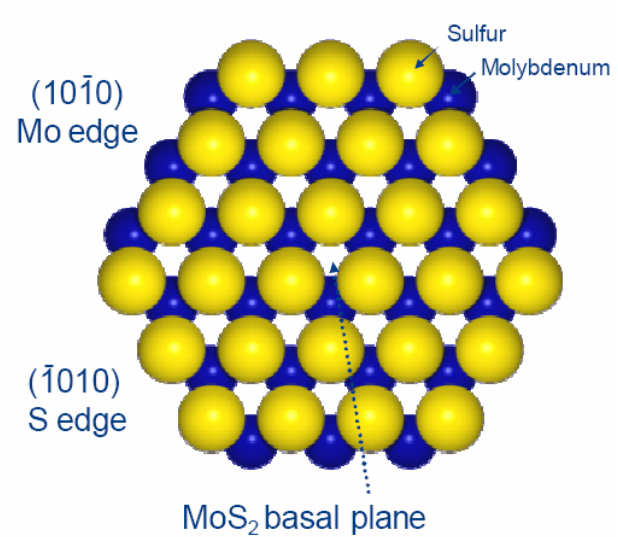

Mo-edge  
(0%)

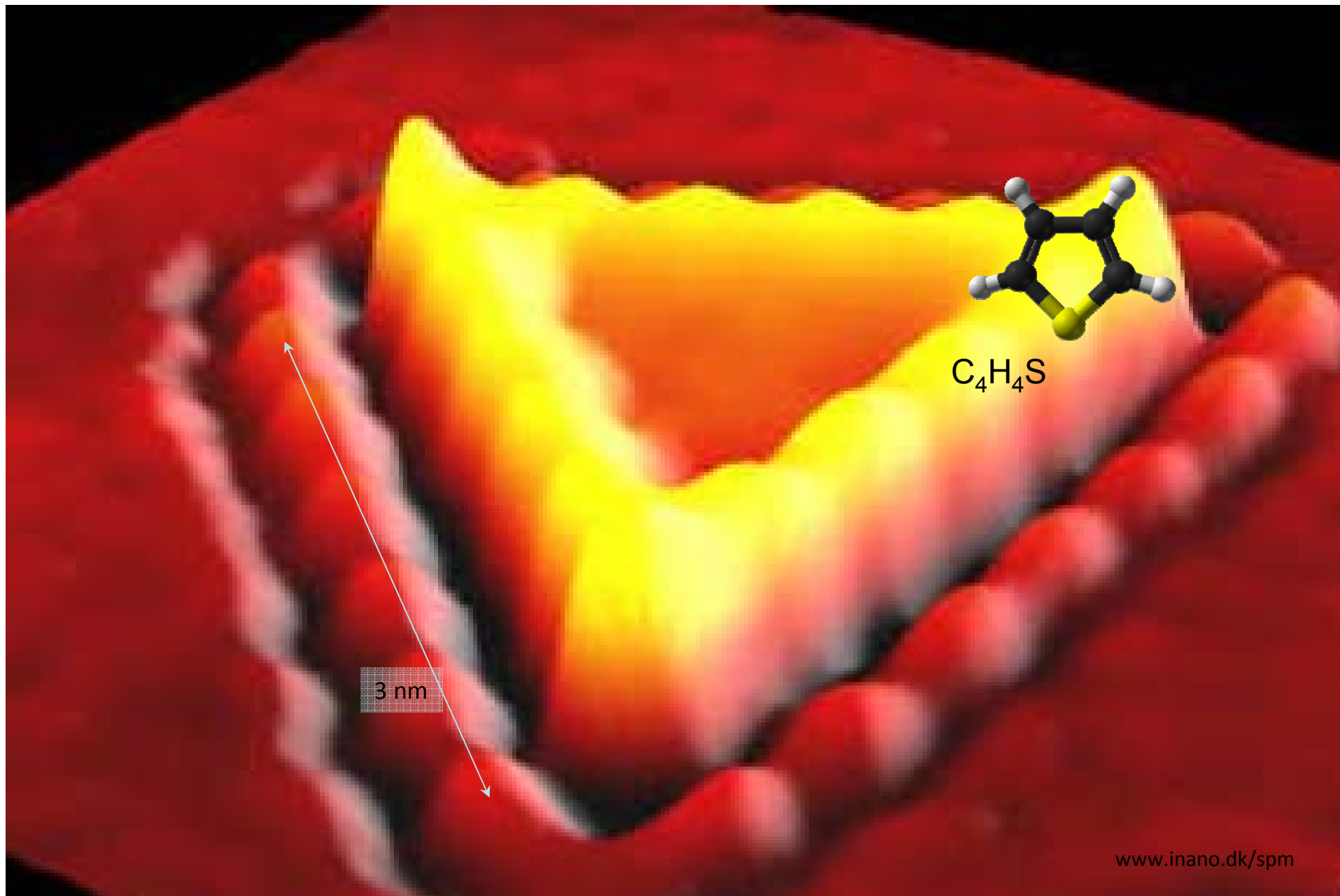

Thiophene adsorption on  $MoS_2$  nanoclusters

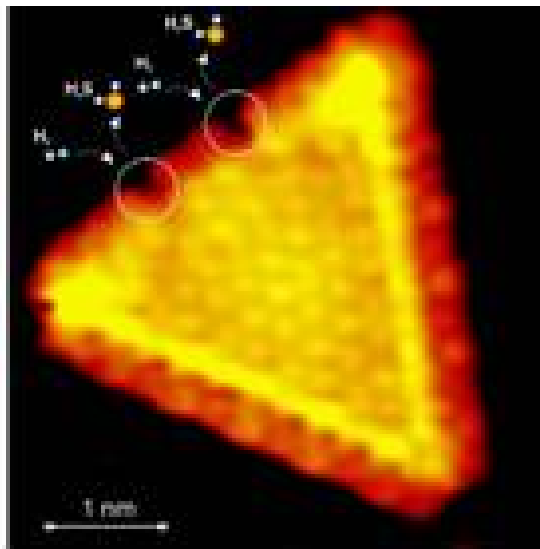
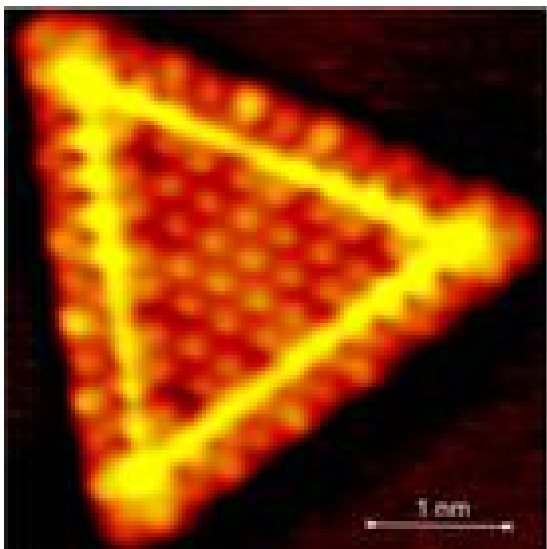

Left: Atom-resolved STM image of an MoS<sub>2</sub> nanocluster which is active as catalyst for removal of S from crude oil.

The cluster is 3 nm wide and consists of 78 Mo atoms and 204 S atoms.

Right: An STM image of the MoS<sub>2</sub> particle in its catalytically active state. Circles indicate single S atoms that have been removed by reaction with hydrogen gas.

The illustration shows an atom-resolved STM image of a triangular  $\sim 3$  nm wide MoS<sub>2</sub> particle supported on a Au support. Only the edges of the nanoparticles are reactive. The STM studies have revealed the exact atomic structure of the edges, and have shown that sulfur vacancies form on these edges. Using the STM it has been possible directly followed the first step of a hydrodesulfurization reaction occurring on the edges of the triangular MoS<sub>2</sub> nanoclusters, which showed that the sulfur vacancies on the edges have the ability to bond S-bearing molecules and subsequently cleave C-S bonds in a catalytic process.

Additionally, the studies have revealed the surprising catalytic importance of so-called metallic brim states of MoS<sub>2</sub>, which are one-dimensional edge states present only on the edges of MoS<sub>2</sub>.

The metallic character of the brim states present adjacent to the cluster edges can catalyze the hydrogenation and then C-S scission of sterically hindered molecules, and **by optimizing the effect of the brim states it has been possible to make the hydrotreating catalyst more active.**

This is an example on how nanotechnology discoveries performed under controlled laboratory conditions can successfully assist the development of real technical catalysts operating in industrial plants.

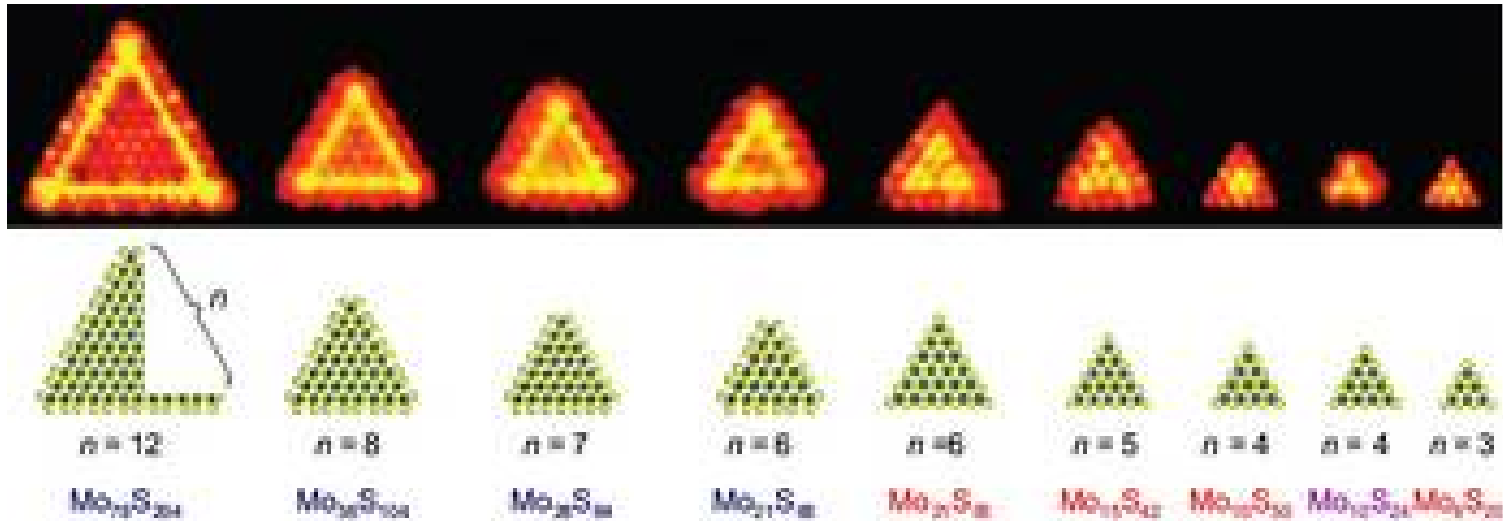

A sequence of STM images of  $\text{MoS}_2$  nanoparticles with a varying size

The control of nanoparticle size in  $\text{Mo}(\text{Co}, \text{Ni})\text{S}_2$ -based catalyst may also offer new opportunities to optimize the catalytic reactivity;

the structure (and in particular the edge structure and therefore the reactivity) changes as the size of the  $\text{MoS}_2$  nanoparticles.

Current efforts are aimed at elucidating the optimum nanoparticles size for hydrotreating reaction of severely sterically hindered molecules.