



JRC SCIENCE AND POLICY REPORTS

Best Available Techniques (BAT) Reference Document for the Refining of Mineral Oil and Gas

*Industrial Emissions Directive
2010/75/EU
(Integrated Pollution
Prevention and Control)*

Pascal Barthe, Michel Chaugny, Serge Roudier,
Luis Delgado Sancho

2015

BAT in Chemical Industry

Prof. dr. sc. Ante Jukić

Petroleum Refining





- the aim is to provide a clear insight and selection of the best available techniques for the desired reduction of harmful emissions into the air from the oil refinery



THE BIGGER PICTURE

Life Without Oil

NOT AS SIMPLE AS YOU MAY THINK

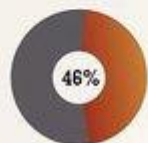

46% of oil goes to making gasoline, but what makes up the other 54%?



Medicine

Most over the counter medications, homeopathic products and vitamins are derived from benzene, a product of petroleum.



Cosmetics

Makeup and shampoo that has oils, perfumes, waxes and color are all produced with the help of petrochemicals.



Plastics

Almost all plastics are made from petrochemicals, from your iPhone to that bottle of water. It is 4-5% of the total petroleum consumption.



Synthetic Rubber

Thousands of products rely on rubber such as shoes, tires, wet suits, breast implants, gloves.



Cleaning Products

All those ingredients you can't pronounce in the ingredients list, all of which are very poisonous.



Asphalt

There are over 11 million miles of paved road in the world. Asphalt aka bitumen is the glue that binds the minerals together.

A few other products made with Oil

Insecticides, Ink, Floor Wax, Pens, Upholstery, Clothing, Boats, Sports Car Bodies, Nail Polish, Fishing Lures, Bags, Perfumes, Cassettes, Dishwasher Parts, Tool Boxes, Shoe Polish, Helmets, Caulking, Petroleum Jelly, Tape, Washers, Antiseptics, Curtains, Food Preservatives, Basketballs, Soap, Antihistamines, Purses, Dashboards, Cortisone, Deodorant, Footballs, Putty, Dyes, Panty Hose, Refrigerant, Percolators, Life Jackets, Rubbing Alcohol, Linings, Skis, TV Cabinets, Shag Rugs, Electrician's Tape, Tool Racks, Car Battery Cases, Epoxy, Paint, Mops, Slacks, Insect Repellent, Oil Filters, Umbrellas, Yarn, Fertilizers, Hair Coloring, Roofing, Toilet Seats, Fishing Rods, Lipstick, Denture Adhesive, Linoleum, Speakers, Plastic Wood, Electric Blankets, Glycerin, Tennis Rackets, Rubber Cement, Dice, Nylon Rope, Candles, Trash Bags, Paint, Water Pipes, Hand Lotion, Roller Skates, Surf Boards, Shampoo, Wheels, Paint Rollers, Shower Curtains, Guitar Strings, Luggage, Safety Glasses, Antifreeze, Awnings, Eyeglasses, Toothbrushes, Ice Chests, Combs, CD's & DVD's, Brushes, Detergents, Vaporizers, Balloons, Sun Glasses, Tents, Heart Valves, Crayons, Parachutes, Telephones, Enamel, Pillows, Dishes, Cameras, Anesthetics, Artificial Turf, Artificial Limbs, Bandages, Dentures, Model Cars, Folding Doors, Hair Curlers, Cold Cream, Movie Film, Soft Contact Lenses, Drinking Cups, Fan Belts, Car Enamel, Shaving Cream, Ammonia, Refrigerators, Golf Balls, Toothpaste, and of course Solvents, Diesel Fuel, Motor Oil, Bearing Grease etc. etc. etc.

Global Oil Refinery Complex and Daily Capacity

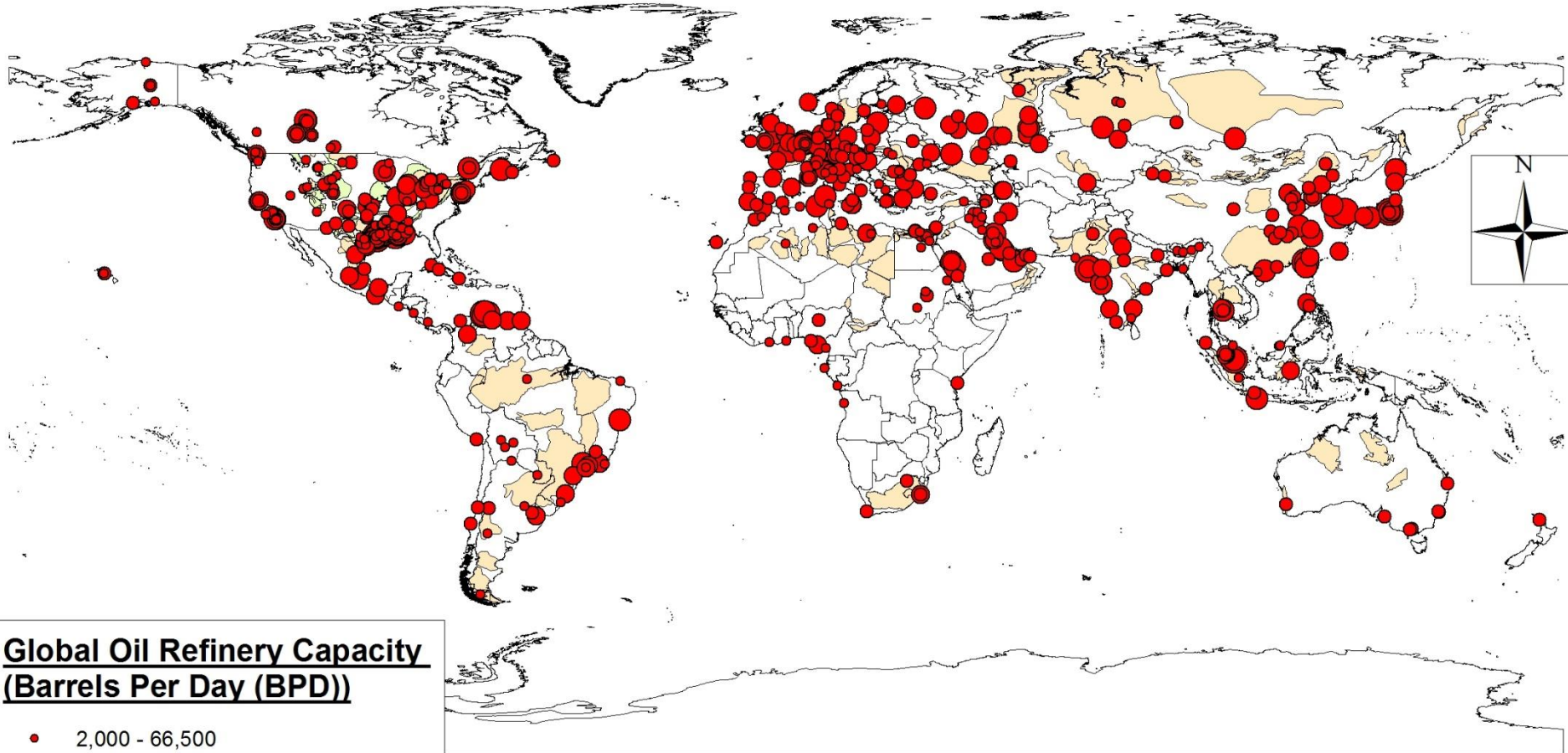

Global Oil Refinery Capacity (Barrels Per Day (BPD))

- 2,000 - 66,500
- 66,501 - 152,000
- 152,001 - 262,000
- 262,001 - 428,000
- 428,001 - 880,000

Global Oil & Gas Shale Plays

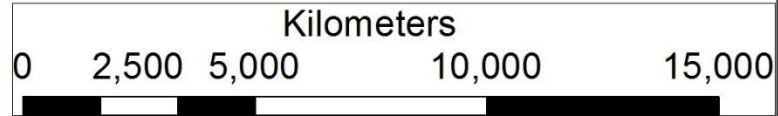

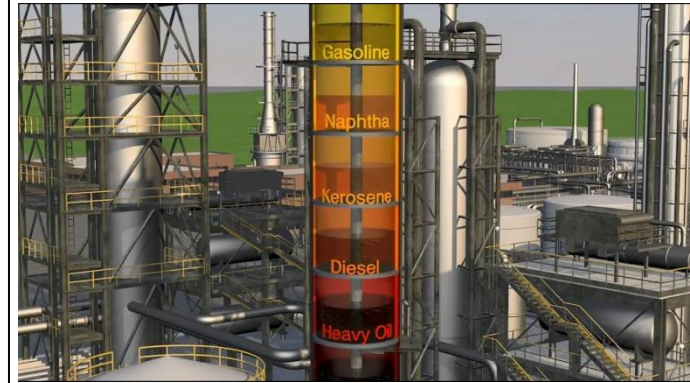
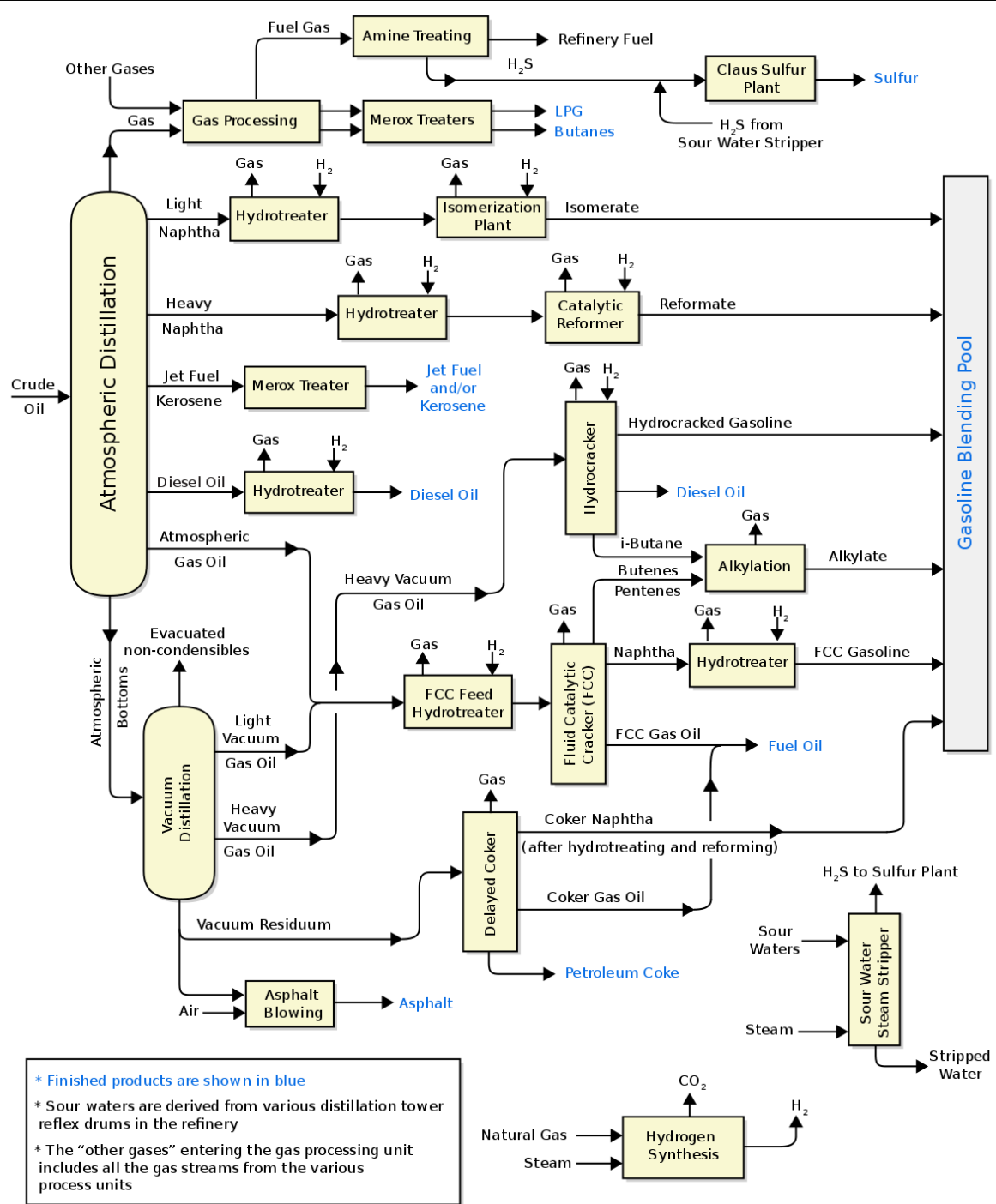

How an oil refinery can pollute the air

This simplified diagram of an oil refinery shows some of the parts that can release hazardous chemicals and gases into the air:

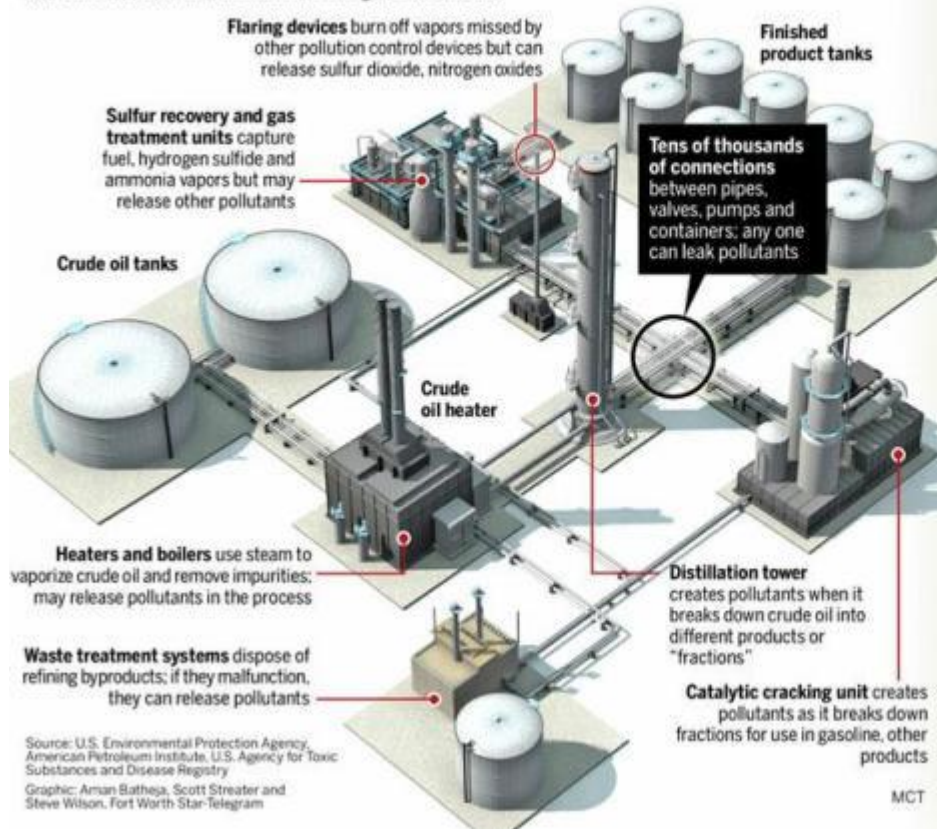

Source: U.S. Environmental Protection Agency, American Petroleum Institute, U.S. Agency for Toxic Substances and Disease Registry
Graphic: Aman Batheja, Scott Streater and Steve Wilson, Fort Worth Star-Telegram

Refinery air pollutants

Ammonia gas

Irritates tissues; low level can irritate eyes, nasal passages; high level can kill

Benzene

Carcinogen, may harm fetuses; can cause dizziness, sleepiness, convulsions, rapid pulse, coma or death

Hydrogen sulfide

"Rotten egg" gas; inhaling even a small amount can kill

Nitrogen oxides

Source of ground-level ozone, which can trigger asthma attacks, aggravate bronchitis, emphysema, other chronic respiratory diseases

Volatile organic compounds

Another source of ozone; linked to cancer, lung and immune system damage

Sulfur dioxide

Tiny particles linked to numerous respiratory problems; with water vapor, creates acid rain

Microscopic particles

Lodge deep inside lungs, can cause asthma, heart attack, premature death

Carbon monoxide

Gas from smokestacks, vehicle tailpipes; high amounts deprive brain of oxygen, can cause brain damage and death

MCT

Emmissions ?

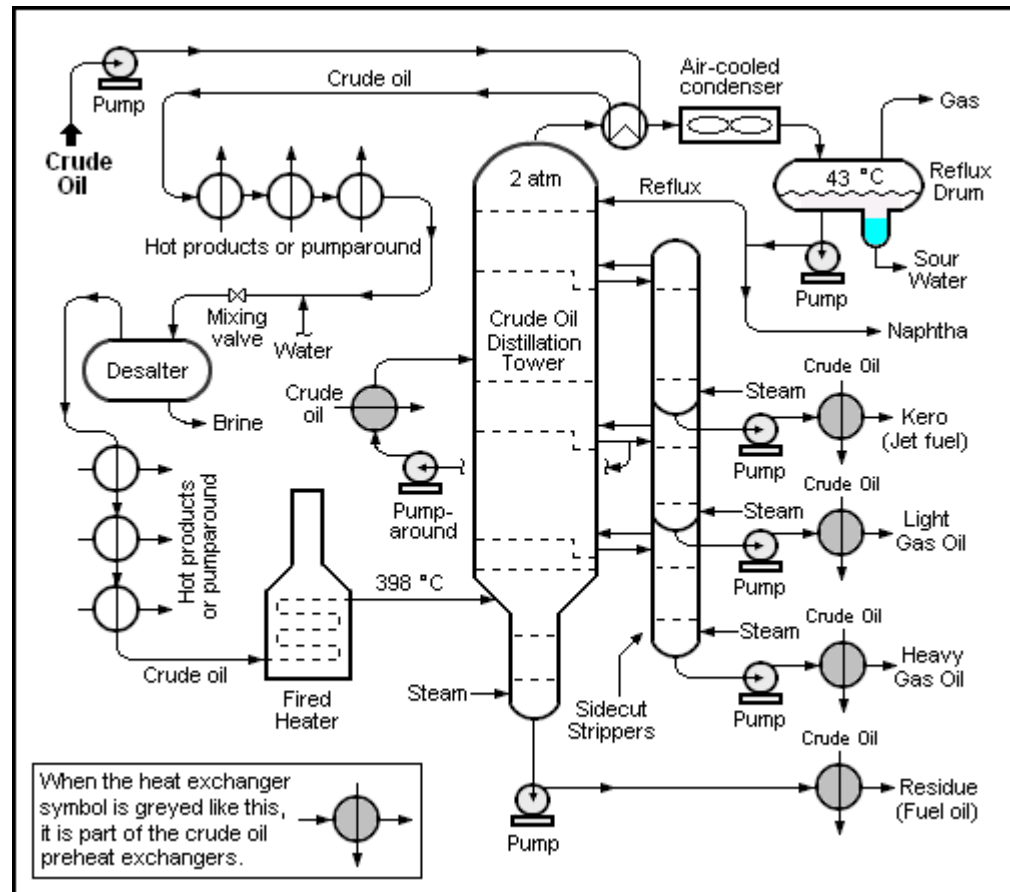

Refinery Process Air Emissions

The most significant air emission sources in oil refineries are catalytic or thermal cracking units, catalytic reformer units, sulfur recovery plants, storage vessels, fluid coking units, wastewater streams, cooling towers, equipment leaks, blowdown systems, vacuum distillation units, steam boilers, process furnaces, process heaters, compressor engines, barge or ship loading and gasoline loading racks specifically located at petroleum refineries.

- in many cases these refinery air emissions have already been controlled in order to meet specific air emission regulations.

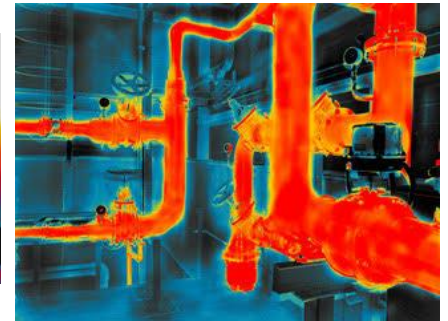
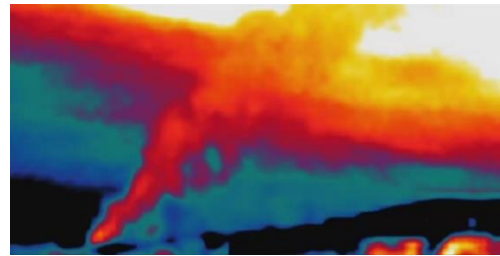

Significant Refinery Air Emission Sources, Air Pollutants And Emission Factors*

<u>Refinery Process</u>	<u>Air Pollutant</u>	<u>Emission Factor**</u>
Catalytic Cracking (Fluid Bed)	Particulates	242
	Carbon Monoxide	13,700
	Sulfur Dioxide	493
	Nitrogen Oxides	71
	Hydrocarbons	220
	Aldehydes	19
	Ammonia	54
Catalytic Cracking (Moving Bed)	Particulates	17
	Carbon Monoxide	3,800
	Sulfur Dioxide	60
	Nitrogen Oxides	5
	Hydrocarbons	87
	Aldehydes	12
	Ammonia	6
Catalytic Reforming	Hydrocarbons	25
	Inorganic Chlorine	4,450
Sulfur Recovery Plant	Sulfur Dioxide	359 lbs/ton sulfur recovered
	Reduced Sulfur (H ₂ S, CS ₂ , COS)	0.65 lbs/ton sulfur recovered

* Uncontrolled air emissions from US EPA Document AP-42

** Expressed as lbs/1,000 bbl fresh feed unless otherwise specified

Significant Refinery Air Emission Sources, Air Pollutants And Emission Factors*

Storage Vessels	Hydrocarbons	No single emission factor
Fluid Coking	Particulates	523
Wastewater Streams	Hydrocarbons	0.097
Cooling Towers	Hydrocarbons	0.0048
Equipment Leaks	Hydrocarbons	0.034
Blowdown System	Hydrocarbons	580
Vacuum Distillation	Hydrocarbons	50
Steam Boiler, Process Furnace or Process Heater (Below 100 Million Btu/hr capacity)	Particulates	10 lbs/1,000 gallon #6 fuel oil
	Nitrogen Oxides	55 lbs/1,000 gallon #6 fuel oil
	Carbon Monoxide	5 lbs/1,000 gallon #6 fuel oil
	Sulfur Oxides	157 x sulfur percentage in fuel/1,000 gallon #6 fuel oil
Steam Boiler, Process Furnace or Process Heater (Below 100 Million Btu/hr capacity)	Particulates	2 lbs/1,000 gallon distillate oil
	Nitrogen Oxides	20 lbs/1,000 gallon distillate oil
	Carbon Monoxide	5 lbs/1,000 gallon distillate oil
	Sulfur Oxides	142 x sulfur percentage in fuel/1,000 gallon distillate oil
Steam Boiler, Process Furnace or Process Heater (Above 100 Million Btu/hr capacity)	Particulates	2 lbs/1,000 gallon #2 fuel oil
	Nitrogen Oxides	24 lbs/1,000 gallon #2 fuel oil
	Carbon Monoxide	5 lbs/1,000 gallon #2 fuel oil
	Sulfur Oxides	157 x sulfur percentage in fuel/1,000 gallon #2 fuel oil

* Uncontrolled air emissions from US EPA Document AP-42

** Expressed as lbs/1,000 bbl fresh feed unless otherwise specified

Significant Refinery Air Emission Sources, Air Pollutants And Emission Factors*

Compressor Engine (Reciprocating)	Hydrocarbons	1.4 lbs/1000 cubic feet gas fuel
	Carbon Monoxide	0.43 lbs/1000 cubic feet gas fuel
	Nitrogen Oxides	3.4 lbs/1000 cubic feet gas fuel
	Sulfur Oxides	2 x sulfur percentage in fuel/1000 cubic feet gas fuel
Compressor Engine (Gas Turbine)	Hydrocarbons	0.02 lbs/1000 cubic feet gas fuel
	Carbon Monoxide	0.12 lbs/1000 cubic feet gas fuel
	Nitrogen Oxides	0.3 lbs/1000 cubic feet gas fuel
	Sulfur Oxides	2 x sulfur percentage in fuel gas/1000 cubic feet gas fuel
Vessel Loading (Barge)	Hydrocarbons	3.4 lbs/1,000 gallons transferred
Vessel Loading (Ship)	Hydrocarbons	1.8 lbs/1,000 gallons transferred
Gasoline Rack Loading	Hydrocarbons	995 lbs/1,000 gallons transferred

* Uncontrolled air emissions from US EPA Document AP-42

** Expressed as lbs/1,000 bbl fresh feed unless otherwise specified

The main air pollutants are substances that should be taken into account when limiting emission values, among which the following are important for refineries:

- sulfur dioxide (SO_2) and other sulfur compounds
- nitrogen oxides (NO_x) and other nitrogen compounds
- volatile organic compounds (VOC), in particular hydrocarbons (excluding methane)
- sedimentary particles (Particulate Matter, PM), including metals and their compounds
- substances that have been shown to possess cancer properties

Sources and emission - CO₂

- combustion of fossil fuels results in the emission of carbon dioxide CO₂ and water vapor H₂O
- CO₂ is a necessary component for biological life, and when at a normal level there is no negative effect on health, vegetation or materials; however, due to global climate change, efforts are being made to reduce the amount of carbon dioxide produced by the combustion of hydrocarbon fuels as much as possible.
- main sources of CO₂ emissions from the refinery industry:
 - catalytic cracking
 - hydrogen production
 - catalyst regeneration
 - burning of oil deposits
 - infrastructure

Possibilities for reducing CO₂ emissions in refineries are:

- rational use of energy / improving the energy efficiency
- use of fuels containing higher hydrogen content

Requirements for changing the quality of transport fuels due to environmental reasons:

- deep desulfurization of petrol and diesel fuels (< 10 ppm)
- complete removal of aromatic hydrocarbons from the fuel
- increase in cetane number of diesel fuel
- reduction of specific gravity or heavy residues

Technologies for CO₂ emissions reduction (CCS)

- disposal in the depths of the ocean
- disposal in deep aquifers
- disposal in depleted oil and gas deposits (reservoirs)
- disposal as solids in isolated tanks

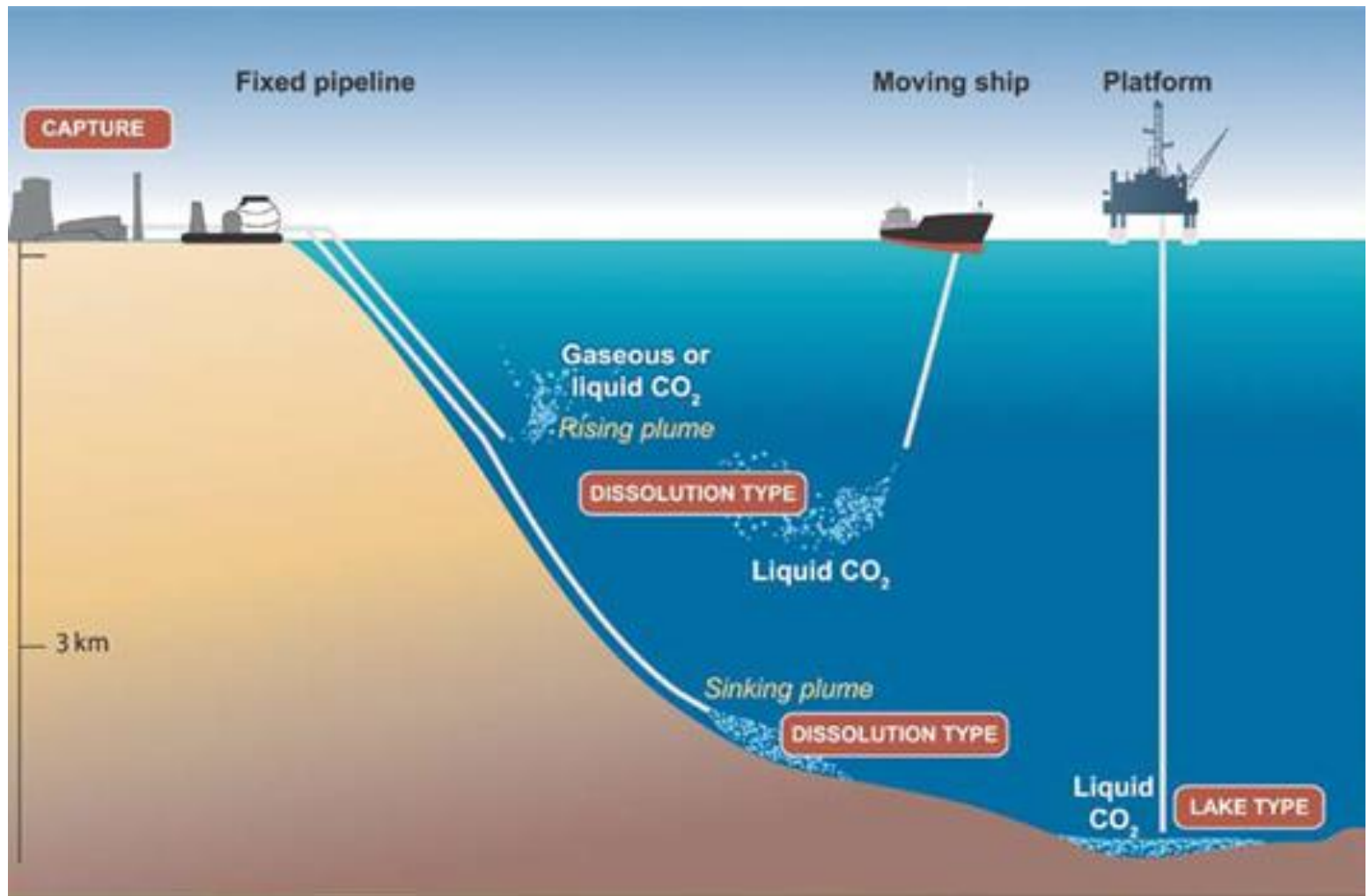

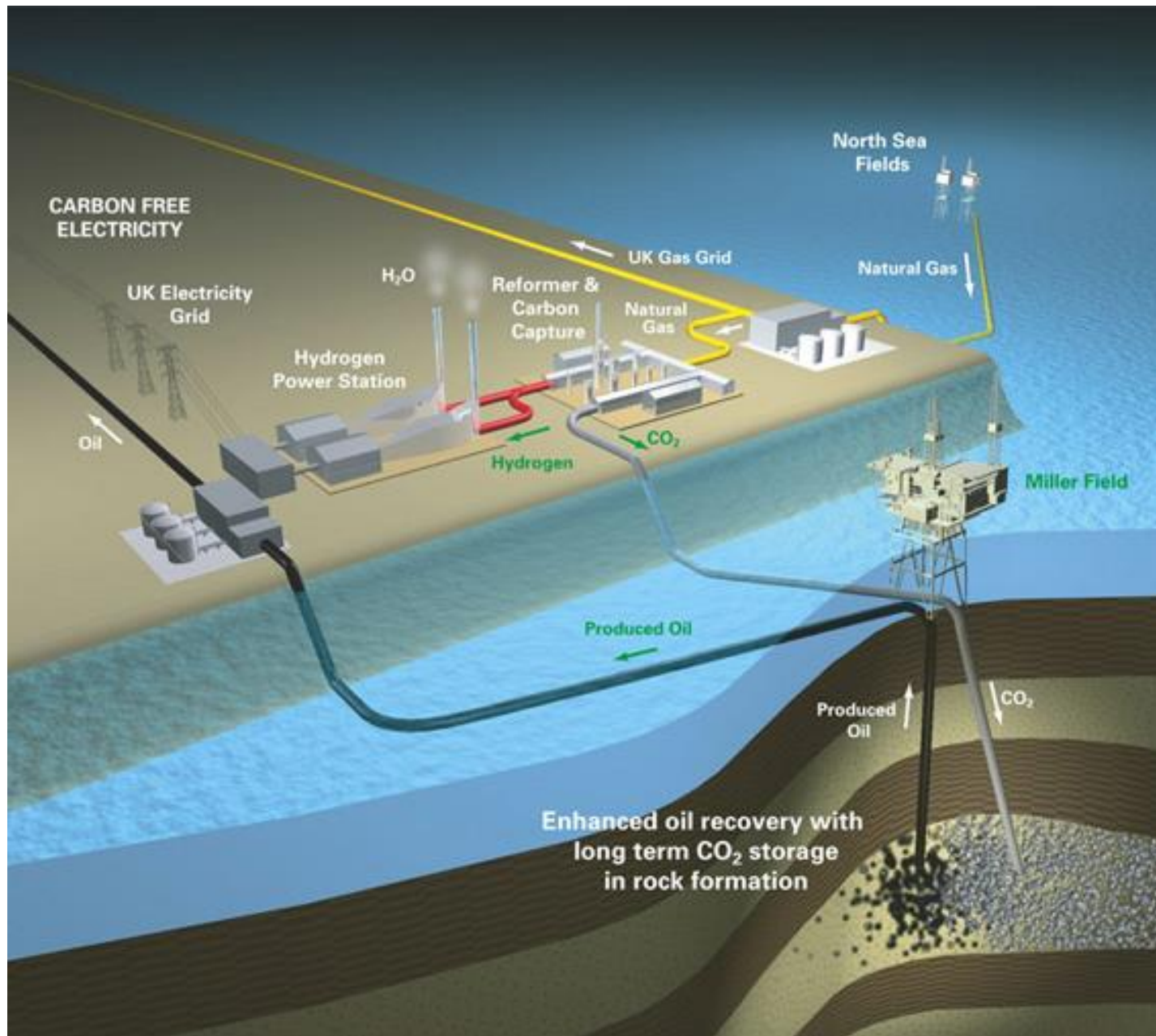

CCS - EOR Miller project, UK, North sea

Mineralisation

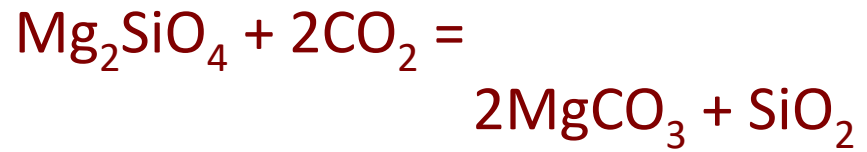
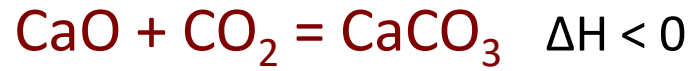

Biological CCS

- Photosynthesis – biomass production



Sources and emission - SO_2

- SO_2 emissions are the result of combustion of fuels containing sulfur

According to the CONCAWE report, the largest source of SO_2 emissions, some 60%, is SO_2 emissions that occur during fuel combustion, followed by SO_2 emissions from FCC units, and from the flare



BAT :

- De-SO_x catalytic additive - is an FCC catalyst additive that binds SO_x components in the regenerator
- Desulphurization of input raw material in FCC - sulfur was removed in the hydrotreatment process
- removal from flue gases - desulfurization - uses adsorption or absorption techniques to remove SO₂, either regenerative or non-regenerative

Sources and emission - NO_x

- NO_x emissions are seen as the sum of nitrogen oxide (NO) and nitrogen dioxide (NO_2) and depend on fuel type (nitrogen and hydrogen content in fuel)
- are increased by using fuels with a higher content of hydrogen and residual fuels containing bonded nitrogen

Source and emissions - VOC-a :

- the main sources of VOC in refineries are output emissions from pipeline systems, wastewater systems, filling and emptying of various systems
- the first level of output emission control is the (LDAR) leak detection and repair detection programme
- burning on a flare - collecting VOC from valves, pumps and compressors and directing them into the flare system

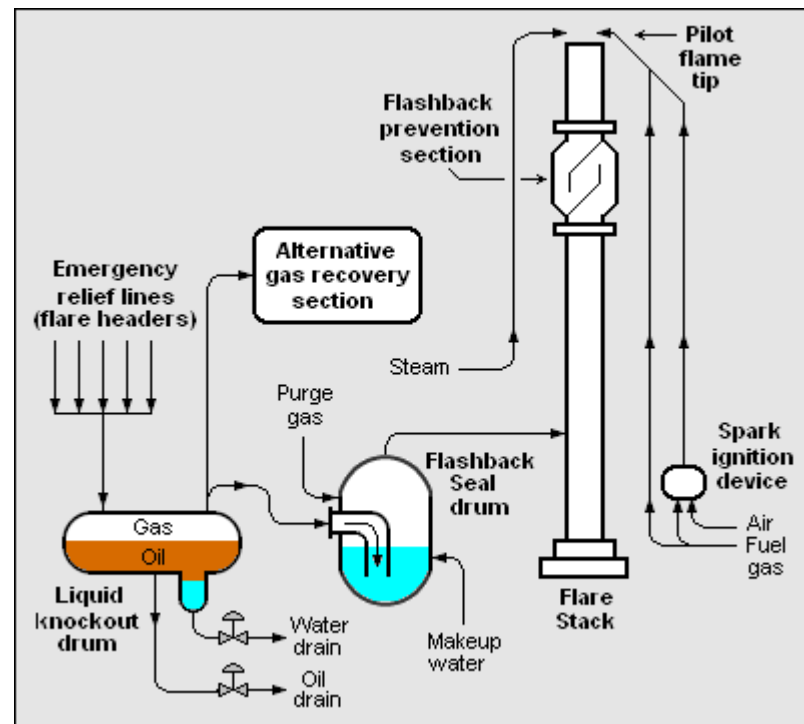

Technologies for **VOC reduction**

- DIAL (Differential Absorption Lidar) system - can be used to establish "hot" concentration points of VOC, and thus zones of large leakage in refinery units
- Long Path Monitors (LPM) systems or detectors can be used for source points, for continuous monitoring of some zones
- SMART LDAR system - this device can detect (using laser technology) hydrocarbon exhaust emissions with the help of a real-time video image of the equipment being monitored

Particulate matter

Main sources:

- process furnaces and boilers (oil combustion)
- catalyst recovery of FCC units for catalytic cracking in the fluidized layer

Emissions may vary depending on fuel type and quality, operating conditions, and the design of burners and furnaces, and for catalyst conditioners depending on the type of equipment for catching and collecting dust/particles (cyclones), as well as catalyst properties

- solid particles in flue gases occur in soot, cenospheric particles, coke particles, and fine particles
- for particulate emissions from FCC units heavy oil fraction is being brought into contact with hot catalyst particles
- cracking reaction occurs – formation of coke

